



**Z8051™ Family of 8-Bit Microcontrollers**

# **Z51F0410 Evaluation Kit**

**User Manual**

UM025704-0413





**Warning:** DO NOT USE THIS PRODUCT IN LIFE SUPPORT SYSTEMS.

---

## **LIFE SUPPORT POLICY**

ZILOG'S PRODUCTS ARE NOT AUTHORIZED FOR USE AS CRITICAL COMPONENTS IN LIFE SUPPORT DEVICES OR SYSTEMS WITHOUT THE EXPRESS PRIOR WRITTEN APPROVAL OF THE PRESIDENT AND GENERAL COUNSEL OF ZILOG CORPORATION.

### **As used herein**

Life support devices or systems are devices which (a) are intended for surgical implant into the body, or (b) support or sustain life and whose failure to perform when properly used in accordance with instructions for use provided in the labeling can be reasonably expected to result in a significant injury to the user. A critical component is any component in a life support device or system whose failure to perform can be reasonably expected to cause the failure of the life support device or system or to affect its safety or effectiveness.

### **Document Disclaimer**

©2013 Zilog, Inc. All rights reserved. Information in this publication concerning the devices, applications, or technology described is intended to suggest possible uses and may be superseded. ZILOG, INC. DOES NOT ASSUME LIABILITY FOR OR PROVIDE A REPRESENTATION OF ACCURACY OF THE INFORMATION, DEVICES, OR TECHNOLOGY DESCRIBED IN THIS DOCUMENT. ZILOG ALSO DOES NOT ASSUME LIABILITY FOR INTELLECTUAL PROPERTY INFRINGEMENT RELATED IN ANY MANNER TO USE OF INFORMATION, DEVICES, OR TECHNOLOGY DESCRIBED HEREIN OR OTHERWISE. The information contained within this document has been verified according to the general principles of electrical and mechanical engineering.

Z8051 is a trademark or registered trademark of Zilog, Inc. All other product or service names are the property of their respective owners.

# Revision History

Each instance in the Revision History table below reflects a change to this document from its previous version.

<b>Date</b>	<b>Revision Level</b>	<b>Description</b>	<b>Page</b>
Apr 2013	04	Updated schematic diagrams.	<a href="#">37</a> , <a href="#">38</a>
Dec 2012	03	Corrected Figures 5 and 7.	<a href="#">7.9</a>
Dec 2012	02	Corrected formatting issue in Table 2.	<a href="#">16</a>
Nov 2012	01	Original issue.	All

# Table of Contents

Revision History . . . . .	iii
List of Figures . . . . .	v
List of Tables . . . . .	vii
Introduction . . . . .	1
Install the Z8051 OCD Software and Documentation . . . . .	5
Configure the Z8051 OCD and Z51F0410 Evaluation Board . . . . .	15
Build and Run the Z51F0410 Demo Project . . . . .	18
Sample Projects and Documentation . . . . .	36
Appendix A. Schematic Diagrams . . . . .	37
Appendix B. OCD Driver Installation on Windows Vista Systems . . . . .	39
Appendix C. OCD Driver Installation on Windows XP Systems . . . . .	42
Appendix D. Stand-Alone Flash Programming Using the Keil $\mu$ Vision IDE . . . . .	45
Customer Support . . . . .	47

# List of Figures

Figure 1.	The Z51F0410 Evaluation Kit . . . . .	1
Figure 2.	Z51F0410 Evaluation Board . . . . .	2
Figure 3.	Block Diagram of the Z51F0410 Evaluation Board . . . . .	3
Figure 4.	Install Device Driver Dialog, Windows 7 . . . . .	6
Figure 5.	Browse For Driver Dialog, Windows Vista . . . . .	7
Figure 6.	Can't Verify Publisher Dialog, Windows Vista . . . . .	8
Figure 7.	Successfully Installed Dialog, Windows Vista . . . . .	9
Figure 8.	Unsuccessful Installation, Scenario 1 . . . . .	10
Figure 9.	Unsuccessful Installation, Scenario 2 . . . . .	11
Figure 10.	Device Manager Dialog, Windows 7 . . . . .	12
Figure 11.	A Successful USB-to-UART Driver Installation . . . . .	14
Figure 12.	Connecting the 10-Circuit Cable to the Board . . . . .	15
Figure 13.	Connecting the Evaluation Board's P1 Port to the USB Port . . . . .	16
Figure 14.	An Example Setup . . . . .	17
Figure 15.	Initial OCD Screen . . . . .	19
Figure 16.	Object File Dialog . . . . .	20
Figure 17.	Configuration Dialog . . . . .	21
Figure 18.	A Typical On-Chip Debugger Window . . . . .	22
Figure 19.	A Typical On-Chip Debugger with Child Windows Open . . . . .	23
Figure 20.	Reset Toolbar Icon . . . . .	23
Figure 21.	HyperTerminal Message After Selecting Go . . . . .	24
Figure 22.	Z51F0410 Demo Program . . . . .	25
Figure 23.	Selecting the Demo Project File . . . . .	27
Figure 24.	Selecting the Target . . . . .	28
Figure 25.	Selecting the Target Driver . . . . .	29
Figure 26.	Configuring the Debug Options . . . . .	30
Figure 27.	Configuring the Flash Options . . . . .	31
Figure 28.	Load Application at Startup Settings . . . . .	31

Figure 29. Beginning a Debug Session .....	32
Figure 30. A Default Debug Session .....	32
Figure 31. Demo Program Menu in HyperTerminal .....	35
Figure 32. Z51F0410 Evaluation Board, #1 of 2 .....	37
Figure 33. Z51F0410 Evaluation Board, #2 of 2 .....	38
Figure 34. Found New Hardware Dialog, Windows Vista .....	39
Figure 35. Install Device Driver Dialog, Windows Vista .....	40
Figure 36. Couldn't Find Driver Dialog, Windows Vista .....	41
Figure 37. The Found New Hardware Wizard Welcome Screen .....	42
Figure 38. The Found New Hardware Wizard's Browse Screen .....	43
Figure 39. Selecting A Target Driver For Flash Programming .....	45
Figure 40. Configuring Additional Flash Options .....	46
Figure 41. The Keil IDE Flash Menu .....	46

# List of Tables

Table 1.	Z51F0410000KITG Contents .....	2
Table 2.	Jumper Settings .....	16
Table 3.	Z51F0410 Evaluation Kit Sample Projects .....	36
Table 4.	Z51F0410 Evaluation Kit Documentation .....	36

# Introduction

This manual describes how to set up Zilog's Z51F0410 Evaluation Kit (Zilog part number Z51F0410000KITG) and use it to evaluate your Z8051-based designs and applications.

The Kit features a small Evaluation Board consisting of two LEDs, two pushbuttons, port pin headers and a USB port. The Board features the Z51F0410 MCU in a 10-pin SSOP package, plus a DBG connector to connect the board to a host development PC using the Z8051 USB On-Chip Debugger (OCD) cable. For more details about the Z51F0410 MCU, please refer to the [Z51F0410 Product Specification \(PS0295\)](#).

This document guides you through the following tasks:

- [Install the Z8051 OCD Software and Documentation](#) – see page 5
- [Configure the Z8051 OCD and Z51F0410 Evaluation Board](#) – see page 15
- [Build and Run the Z51F0410 Demo Project](#) – see page 18

Figure 1 displays an image of the Z51F0410 Evaluation Kit.



Figure 1. The Z51F0410 Evaluation Kit



## Kit Contents

Table 1 lists the contents of the Z51F0410 Evaluation Kit.

**Table 1. Z51F0410000KITG Contents**

Item	Description	Quantity
1	Z51F0410 Evaluation Board	1
2	Z8051 USB On-Chip Debugger (OCD)	1
3	Z8051 OCD Target Cable (10ckt)	1
4	USB Cable: A (male) to Mini-B	1
5	Z51F0410 Evaluation Kit Insert (FL0148)	1

Figure 2 displays an image of the Z51F0410 Evaluation Board.

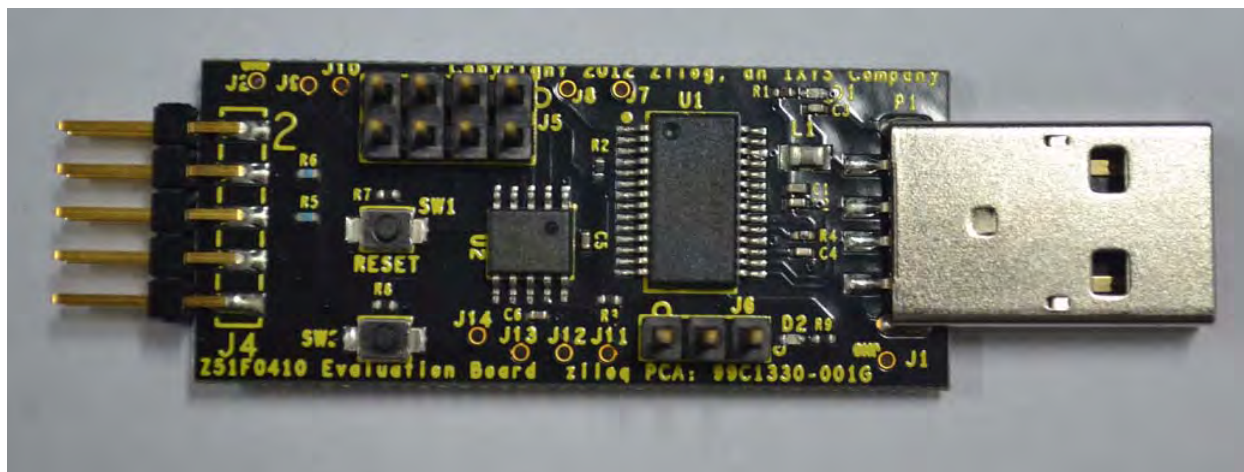

**Figure 2. Z51F0410 Evaluation Board**

## Supported Operating Systems

The Z51F0410 Evaluation Board and the Z8051 On-Chip Debugger support the following operating systems:

- Microsoft Windows XP
- Microsoft Windows Vista (32-bit/64-bit)
- Microsoft Windows 7 (32-bit/64-bit)

## Z51F0410 Evaluation Board Block Diagram

Figure 3 displays a block diagram of the Z51F0410 Evaluation Board.

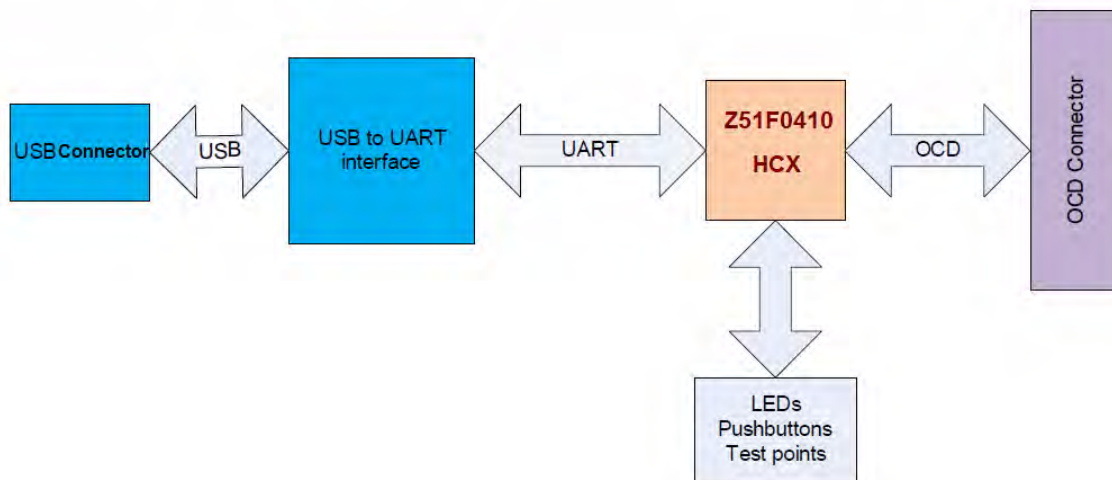

Figure 3. Block Diagram of the Z51F0410 Evaluation Board

## Z51F0410 Evaluation Board Description

The Z51F0410 Evaluation Board contains the following components:

- Z51F0410: U2, 10-pin SSOP chip
- 1 green LED (D2) is connected to the GPIO pin of the Z51F0410 MCU
- 1 green LED (D1) to indicate USB power
- 2 pushbuttons:
  - SW1: RESET
  - SW2 is connected to the GPIO pin on the Z51F0410 MCU
- USB connector: P1
- OCD connector: J4, J3
- USB to UART interface: U1
- USB interface provides power and communication to the Board

- Test points J1 and J2 are connected to Ground; J7–J14 are connected to GPIO pin of U2

When the Board is connected to the USB port of the host PC, the green D1 LED will illuminate (turn ON).

Schematic diagrams of the Z51F0410 Evaluation Board are presented [on pages 37 through 38](#) of this document.

The physical dimensions of the Board are: 1.75" x 0.75" (44.4mm x 19mm).

# Install the Z8051 OCD Software and Documentation

The Z8051 On-Chip Debugger (OCD) interface is the interface by which your PC will communicate with the Z51F0410 MCU to download and execute code. In addition to the OCD, software such as development tools and sample applications will be installed.

## Supported Operating Systems

The Software and Documentation for this reference design supports Microsoft Windows 7 (32-bit/64-bit), Windows Vista (32-bit/64-bit) and Windows XP.

---

► **Note:** If you have already downloaded the Z8051 software and documentation from the Zilog Store and installed it following the procedure on the paper insert in your kit (FL0148), skip this section and proceed to the Z8051 OCD Driver Installation section, below.

---

Observe the following procedure to install the Z8051 On-Chip Debugger software and documentation on your computer.

1. Ensure that the OCD interface hardware is not connected to your PC.
2. In a web browser, download the Z8051 Software and Documentation v2.1 or later from the [Zilog Store](#). When the download is complete, unzip the file to your hard drive and double-click to launch the installation file named `z8051_<version>.exe`.
3. From the main menu, select **Go to the installation page**, then select one of the following options:
  - If you do not plan to use the Keil  $\mu$ Vision4 IDE, select **Zilog OCD + Samples + SDCC**.
  - If you will be using the Keil  $\mu$ Vision4 IDE, select **Zilog OCD + Samples + Keil  $\mu$ Vision4 IDE Debugging Support**.
  - If you only plan to use the programming features and do not plan to perform any development, select **Zilog OCD**.
  - To install all files, select **All of the above**.

---

► **Note:** In this filename, `<version_number>` refers to the version number of the OCD Software and Documentation release. For example, this version number may be 2.1.

---

4. Follow the on-screen instructions to complete the OCD software installation.

## Z8051 OCD Driver Installation

The driver programs for the Z8051 On-Chip Debugger are copied during the software and documentation installation. In the following procedure for PCs running Windows 7 32- and 64-bit operating systems, ensure that the target side of the OCD will remain unconnected while you install these drivers.

---

► **Note:** If you are running Windows Vista, see [Appendix B](#), on page 39 to install your device drivers. If you are running Windows XP, see [Appendix C](#), on page 42.

---

1. Connect the OCD hardware to the USB port of your PC by connecting the A (male) end of the USB A (male)-to-Mini-B cable with the host PC's USB port. Connect the Mini-B end to the OCD device.
2. After the PC detects the new hardware, it will display the *Installing device driver software* dialog shown in Figure 4.



Figure 4. Install Device Driver Dialog, Windows 7

---

**IMPORTANT NOTE:** If you should encounter the scenarios presented in Figures 8 or 9, right-click your mouse on **ZILOG OCD I/F** (highlighted in Figure 8) or **Unknown device** (highlighted in Figure 9) and select **Update Driver Software...**

---

3. Select **Browse my computer for driver software (advanced)** to display the dialog shown in Figure 5, which prompts you to key in or browse for the location of the .inf file. Depending on the type of computer you use (32-bit or 64-bit), use the **Browse** button to navigate to one of the following paths, then click the **Next** button.
  - On 32-bit machines, use the following path:  
<Z8051 Installation>\Z8051\_<version\_number>\device drivers\OCD USB\32

- On 64-bit machines, use the following path:  
<Z8051 Installation>\Z8051\_<version\_number>\device drivers\OCD USB\x64

► **Note:** In the above filepaths, <Z8051 Installation> refers to C:\Program Files\zillog.

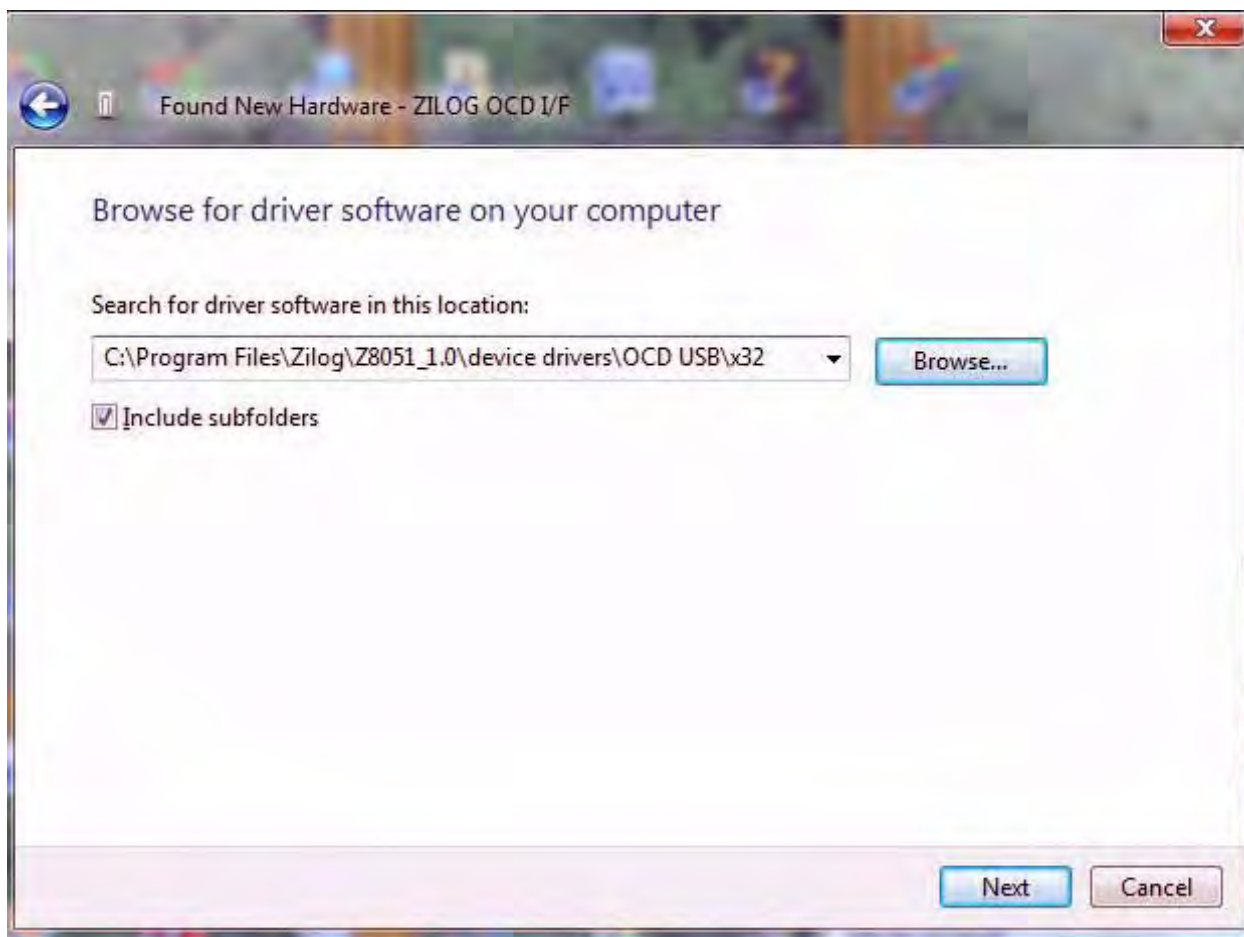

Figure 5. Browse For Driver Dialog, Windows Vista

4. When Windows prompts you whether to install or not install, as shown in Figure 6, click **Install this driver software anyway** and wait until the installation is completed (Windows may prompt you more than once).

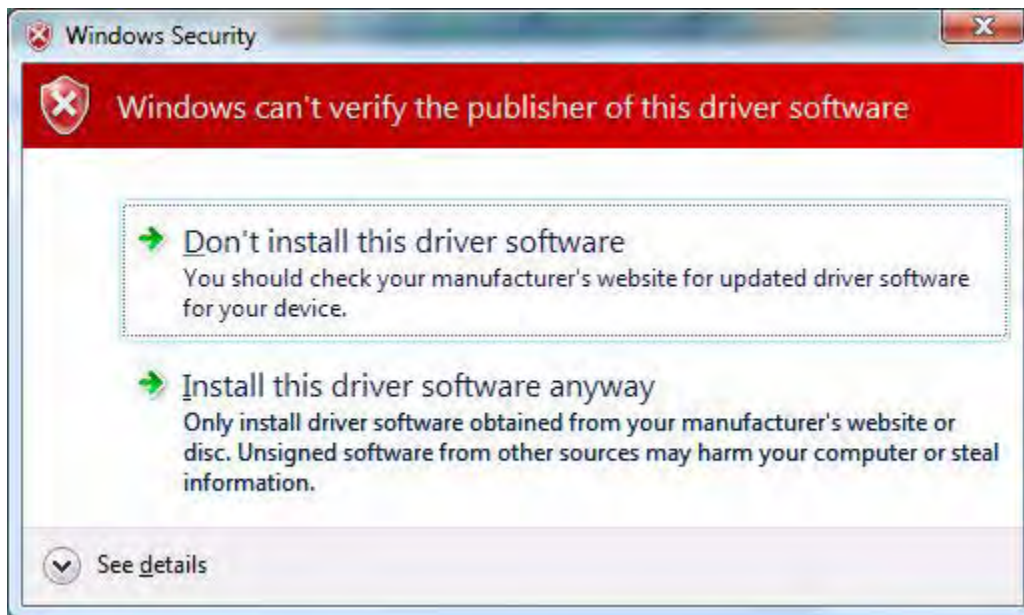
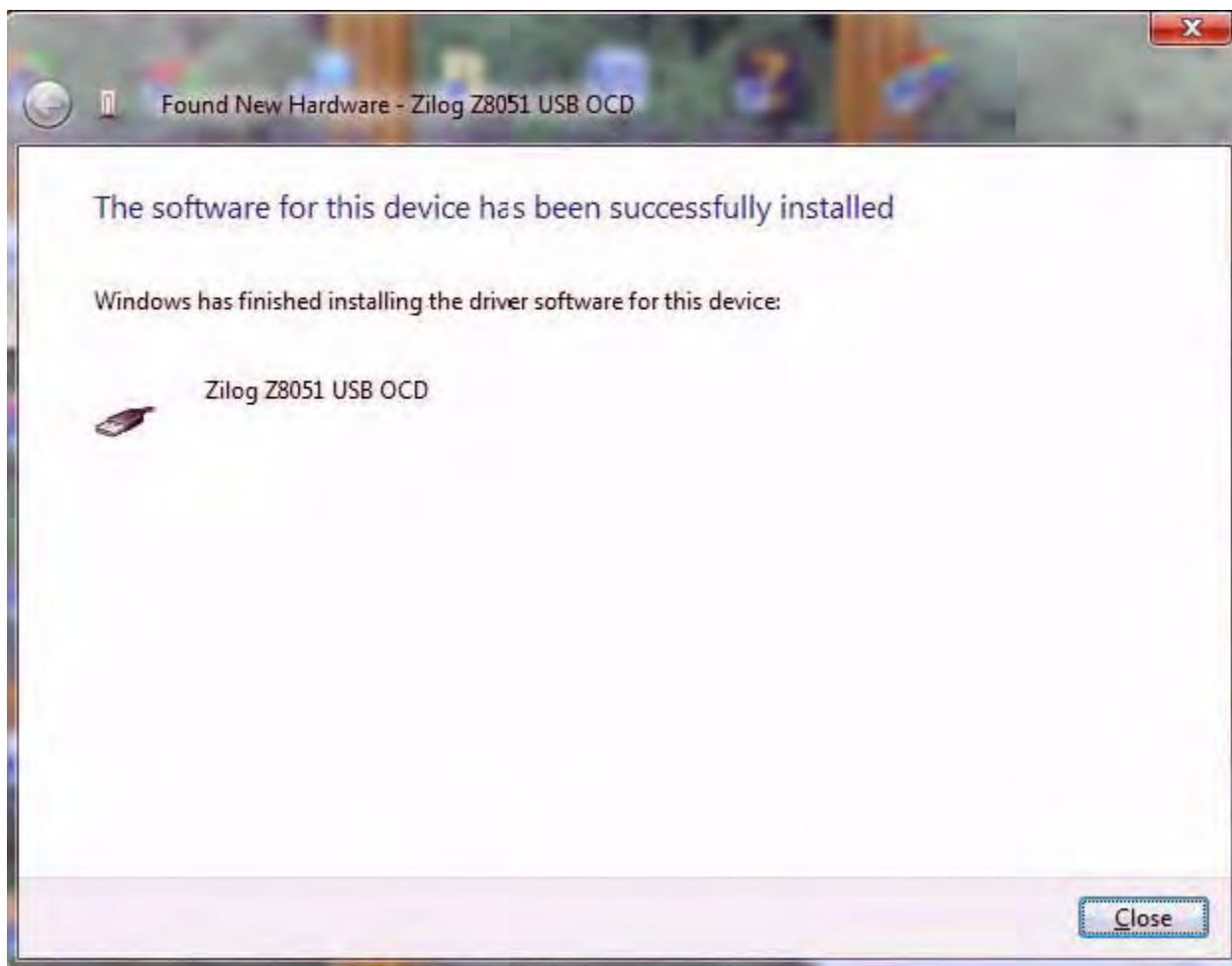

Figure 6. Can't Verify Publisher Dialog, Windows Vista

5. When the installation is complete, the screen shown in Figure 7 will appear. Click **Close** to exit the OCD driver installation.



**Figure 7. Successfully Installed Dialog, Windows Vista**

- 
- **Note:** On some installations, the Found New Hardware screen shown in Figure 7 may also display the text string, Zilog Z8051 USB OCD - No Firmware. This occurrence is normal and can be disregarded.
-



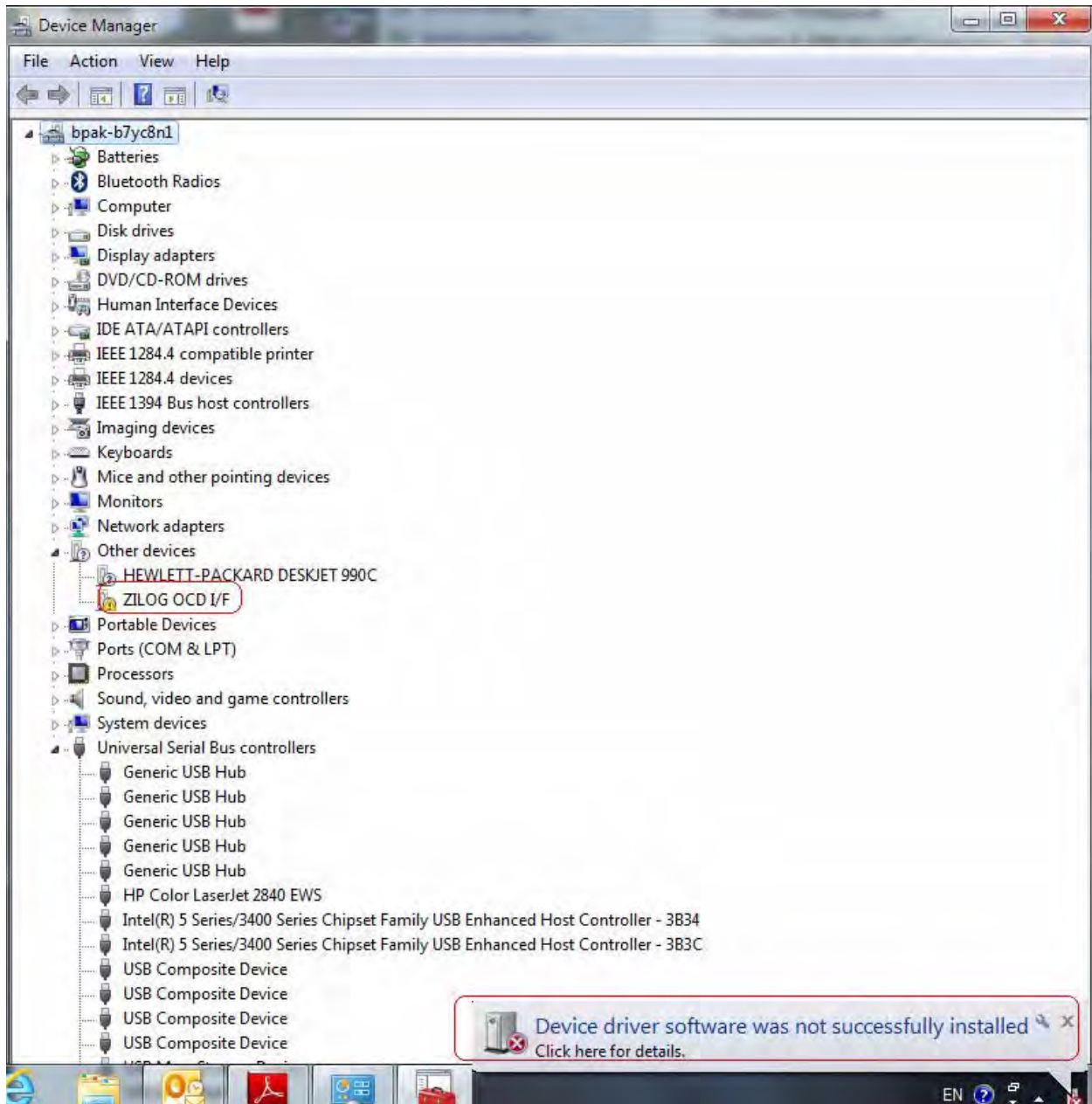

Figure 8. Unsuccessful Installation, Scenario 1

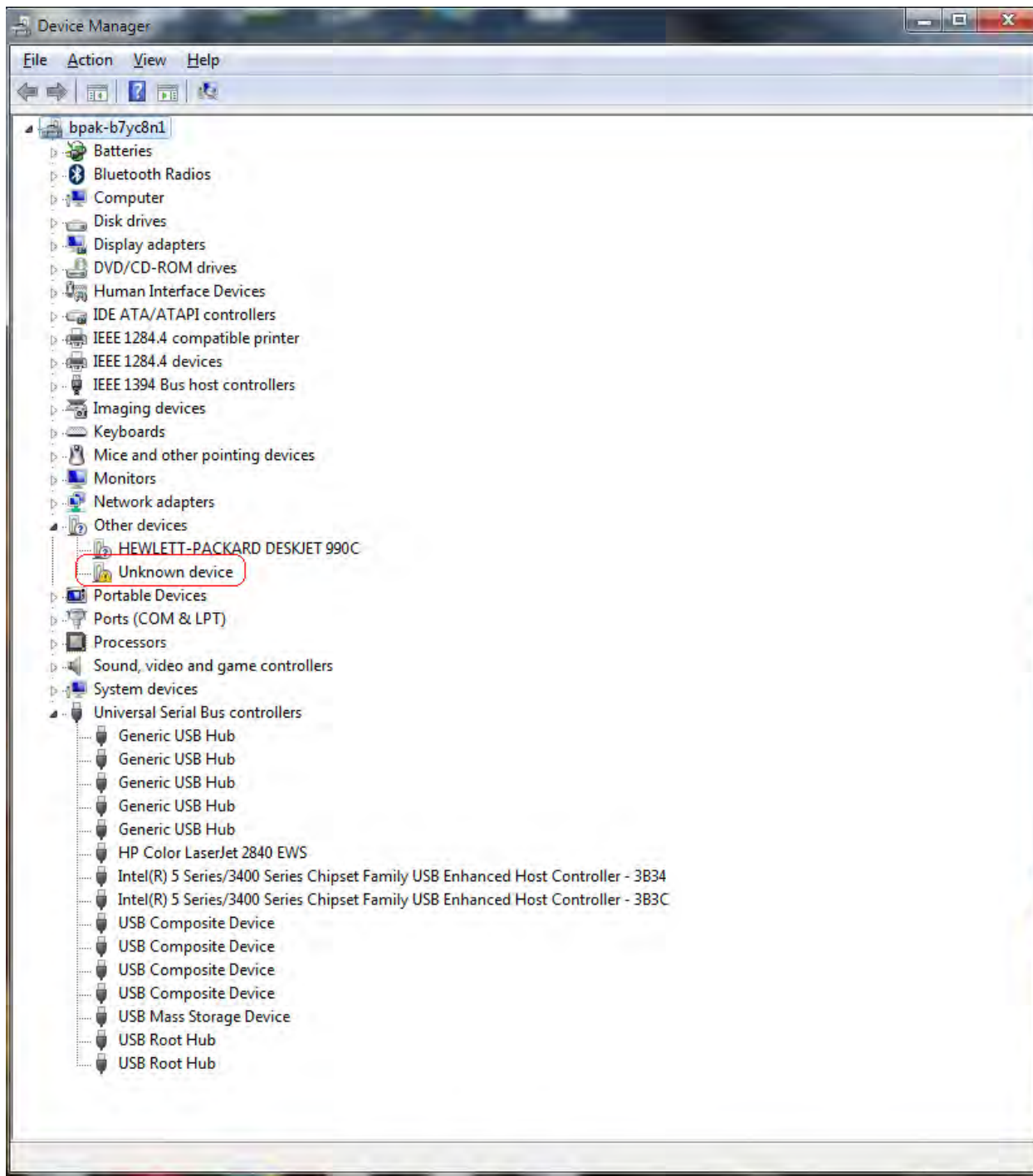

Figure 9. Unsuccessful Installation, Scenario 2

6. If *Zilog Z8051 USB OCD* appears in the Device Manager (as highlighted in Figure 10), the OCD driver software has been successfully installed.

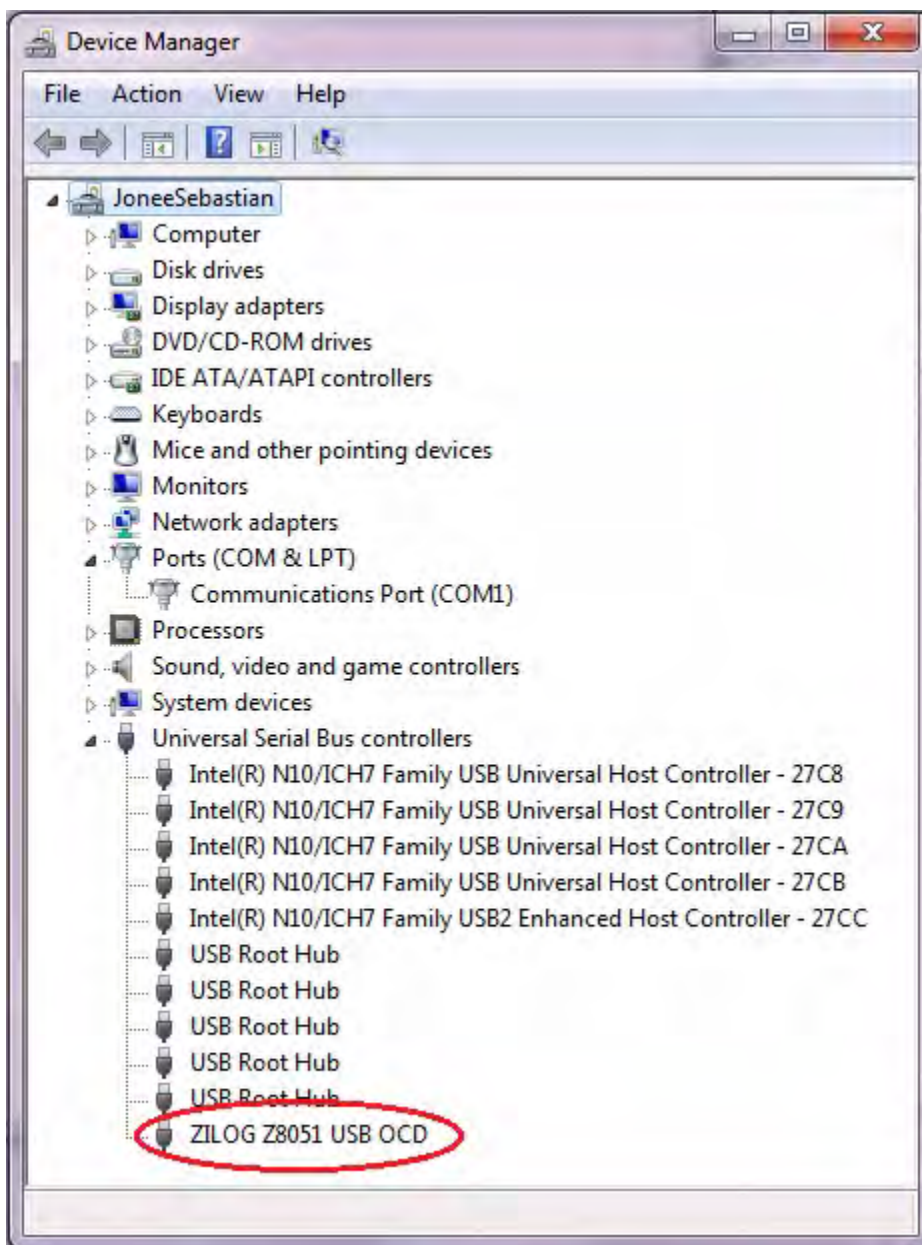

Figure 10. Device Manager Dialog, Windows 7

## FTDI USB-to-UART Driver Installation

An FTDI USB-to-UART driver is required to allow your PC to communicate through its USB port to the on-chip UART of the Z51F0410 MCU. Observe the following procedure to perform these connections.

1. Ensure that the Z51F0410 Evaluation Board's P1 connector is not plugged in to the host PC's USB port.
2. Navigate to the following filepath and double-click the `CDM20802_setup.exe` file to begin the driver installation.

```
<Z8051 Installation>\Z8051_<version_number>\device drivers\FTDI Uart
```

3. The installation process will begin and you should observe output similar to the following messages on the screen of your PC:

```
32-bit OS detected  
<installation path>\dpinstx86.exe  
Installation driver  
FTDI CDM driver installation process completed.
```

---

► **Note:** The above message may appear for a short time, but will then disappear from your window. This occurrence is normal.

---

4. When the installation is complete, plug in the Board's P1 connector into the USB port of your PC. Refer to [Figure 13](#) on page 16 for guidance.
5. If the driver installation was successful, the *Ports (COM & LPT)* section of the Device Manager will display *USB Serial Port (COMx)* or similar message, as highlighted in Figure 11.

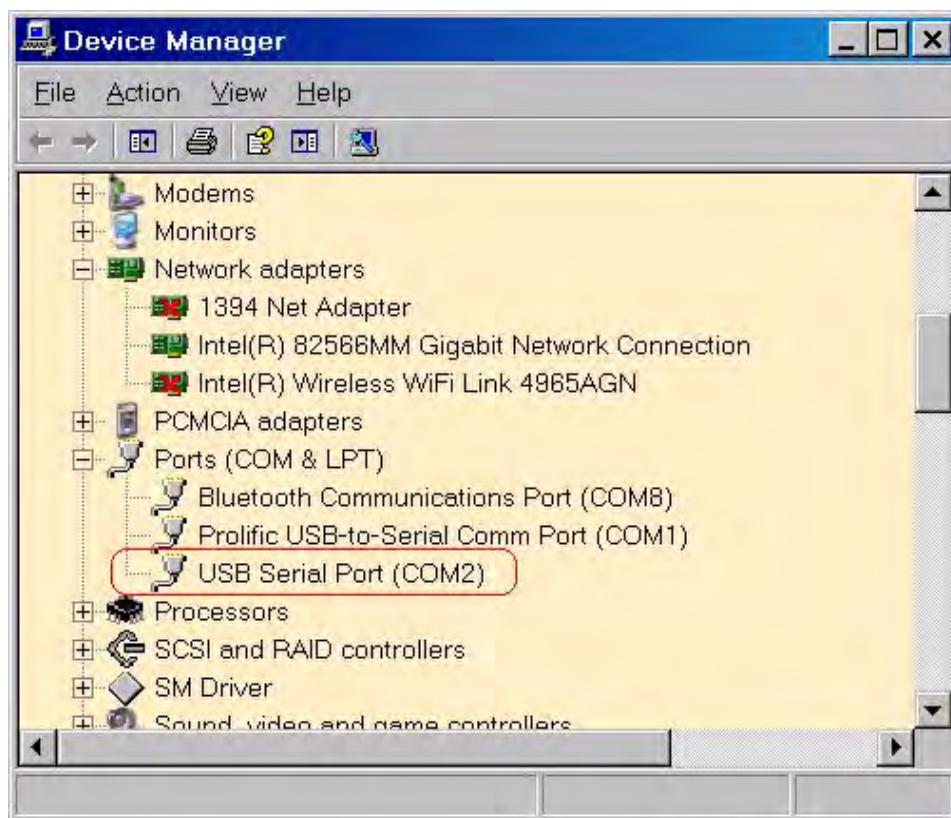



Figure 11. A Successful USB-to-UART Driver Installation

- 
- **Note:**
1. To launch the Device Manager on Windows 7 systems, launch the Start menu, enter *device manager* in the **Search programs and files** field, and press the Enter key.
  2. To open the Device manager on earlier Windows systems, navigate via the following path:  
  
Start → Control Panel → System → Hardware → Device Manager → Ports (COM& LPT)
-

# Configure the Z8051 OCD and Z51F0410 Evaluation Board

Observe the following procedure to set up and configure the Z8051 On-Chip Debugger and the Z51F0410 Board.

---

 **Caution:** Steps number 1 to 4 present the power-up sequence. Carefully follow these steps to avoid encountering an improper connection or disconnection.

---

1. Connect the Z8051 On-Chip Debugger (OCD) to the host PC's USB port.
2. Connect one end of the 10-circuit cable to the Z8051 OCD.
3. Connect the other end of the 10-circuit cable connector to the Z51F0410 Board's J4 and J3 connectors. Pin 1 of the cable connector is indicated by a red stripe, as shown in Figure 12.

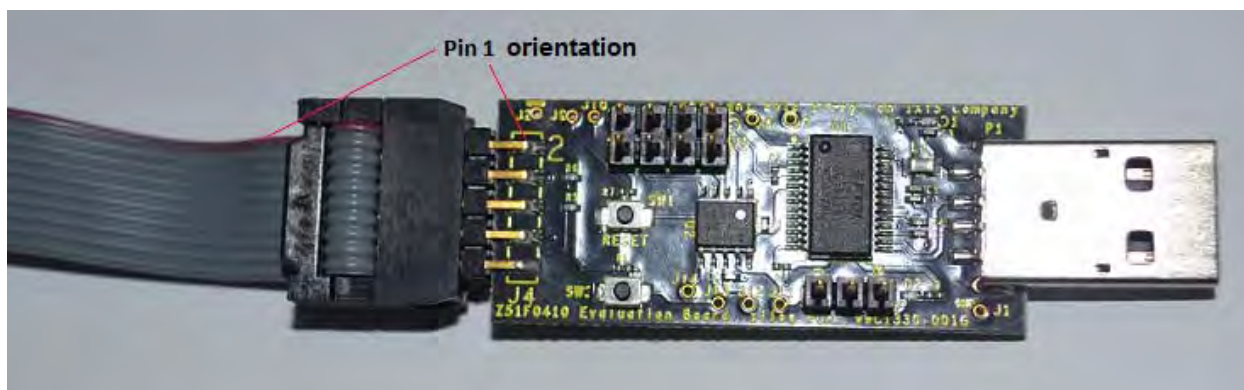

**Figure 12. Connecting the 10-Circuit Cable to the Board**

4. Set the jumpers as indicated in Table 2.

Table 2. Jumper Settings

Jumper	Description	State	Function	Factory Setting
J5	TxD	1–2	TxD_0	IN
		3–4	TxD_1	
	RxD	5–6	RxD_0	IN
		7–8	RxD_1	
J6	D2 LED	1–2	DSDA	IN
		2–3	RxD_1	

5. Connect P1 on the Z51F0410 Board to the host PC's USB port to apply power to the Board, as shown in Figure 13.

- **Notes:**
1. Upon applying power, the green LED (D1) will be illuminated.
  2. When recycling power, Zilog recommends waiting for at least 5 seconds before reapplying power to allow a proper power-on reset.

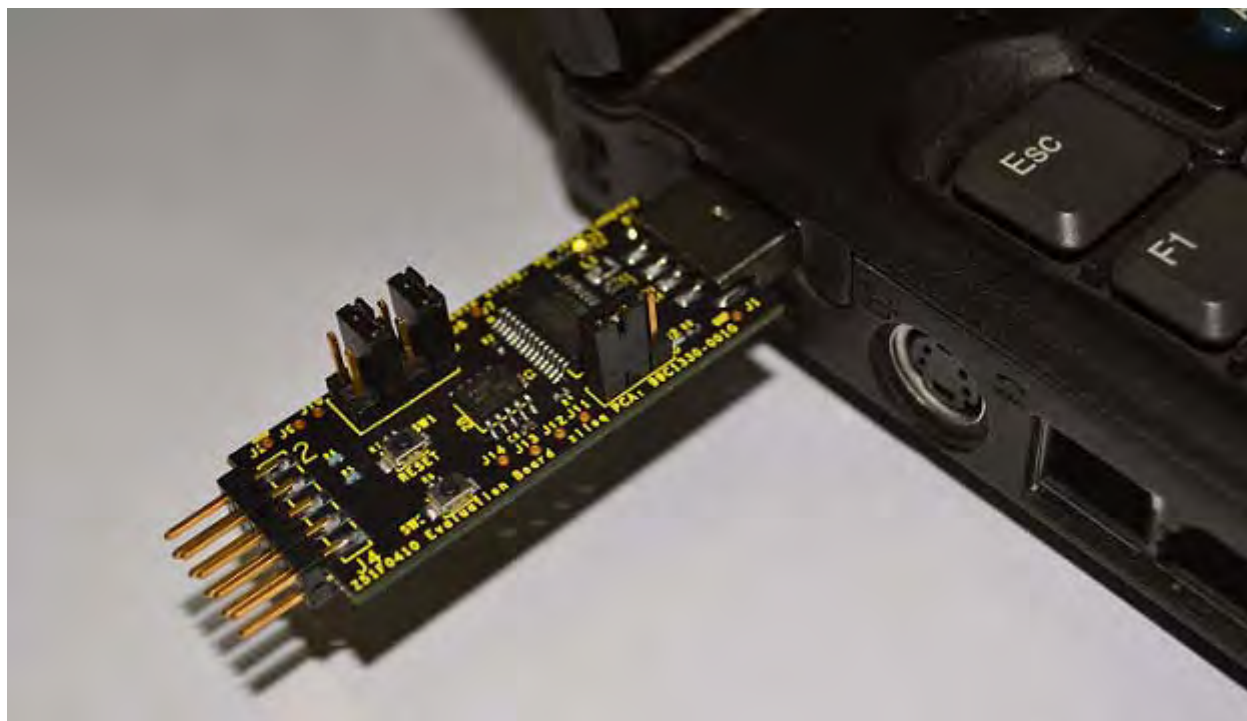

Figure 13. Connecting the Evaluation Board's P1 Port to the USB Port

Figure 14 shows an example of a completed hardware and software setup.



**Figure 14. An Example Setup**



# Build and Run the Z51F0410 Demo Project

Observe the following procedure to build and run the Z51F0410 demo project.

---

► **Note:** If you plan to use the Keil  $\mu$  Vision IDE, please skip to the [Using the Keil  \$\mu\$  Vision IDE on a Demo Project](#) section on page 25.

---

1. Browse to the following location and double-click the `build_sdcc.bat` batch file to build the project:

<Z8051 Installation>\Z8051\_<version\_number>\samples\Z51F0410\Demo\build\_sdcc.bat

---

► **Note:** Refer to the [Z8051 Tools Product User Guide \(PUG0033\)](#) for additional information about these project files and Small Device C Compiler (SDCC) development tools.

---

2. When the build is complete, the command window will prompt the user to press any key to continue. Proceed by pressing any key on your keyboard; as a result, a hex file for the demo will be created in the following path:

<Z8051 Installation>\Z8051\_<version\_number>\samples\Z51F0410\Demo\demo.hex

3. Set up the OCD and Evaluation Board. If you have not already configured these items, please return to the [Configure the Z8051 OCD and Z51F0410 Evaluation Board](#) section on page 15.
4. Run the Z8051 OCD software. From the **Start** menu, navigate to **All Programs** → **Zilog Z8051 SW and Docs <version\_number>** → **Zilog Z8051 OCD <version\_number>**. Once launched, the program will display *Connected*, as shown in Figure 15.

---

► **Note:** If you encounter a message that says *Disconnected*, return to the [Configure the Z8051 OCD and Z51F0410 Evaluation Board](#) section on page 15 to configure the proper power-up sequence. If the problem persists, Zilog recommends that you review the [Z8051 OCD Driver Installation](#) and [FTDI USB-to-UART Driver Installation](#) sections.

---

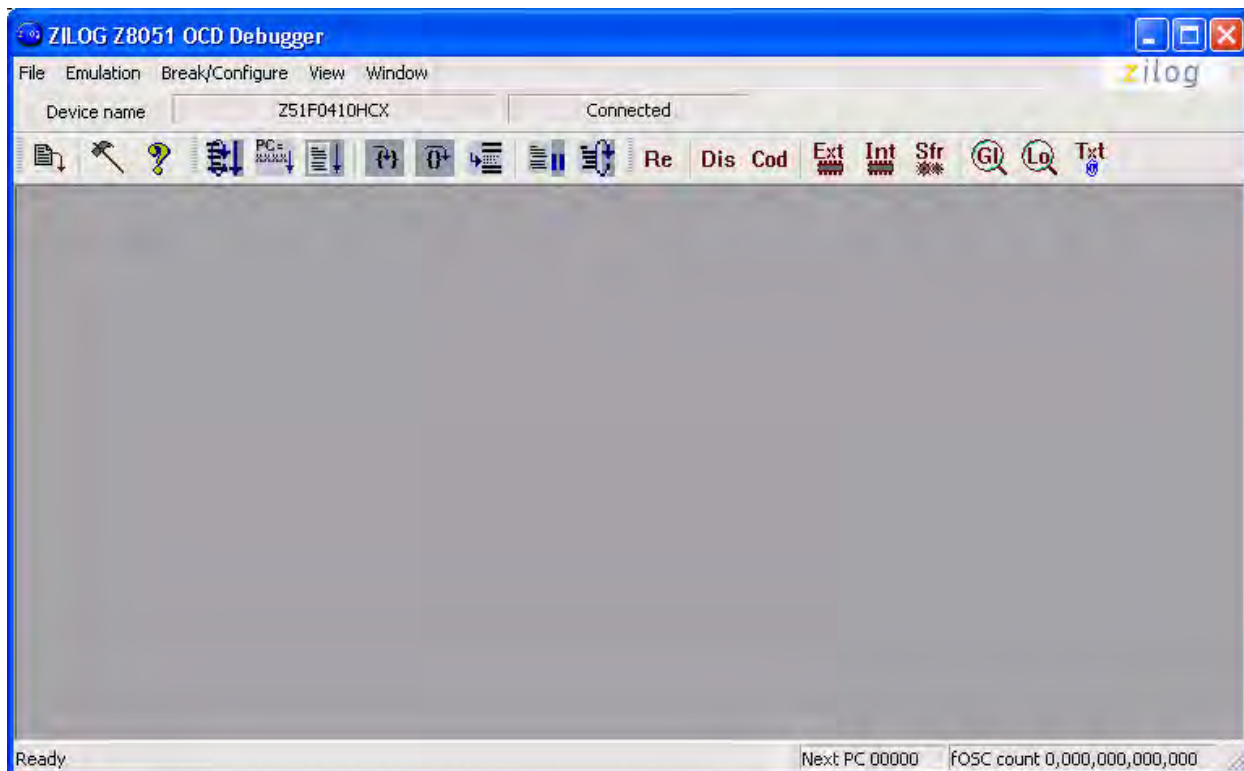

Figure 15. Initial OCD Screen

---

► **Note:** For a free download of the latest version of the OCD software, visit [the Zilog website](#) and navigate via the **Tools and Software** menu to **Software Downloads**.

---

5. In the Debugger window, select **Load Hex** from the **File** menu to display the Object File dialog, which is shown in Figure 16.

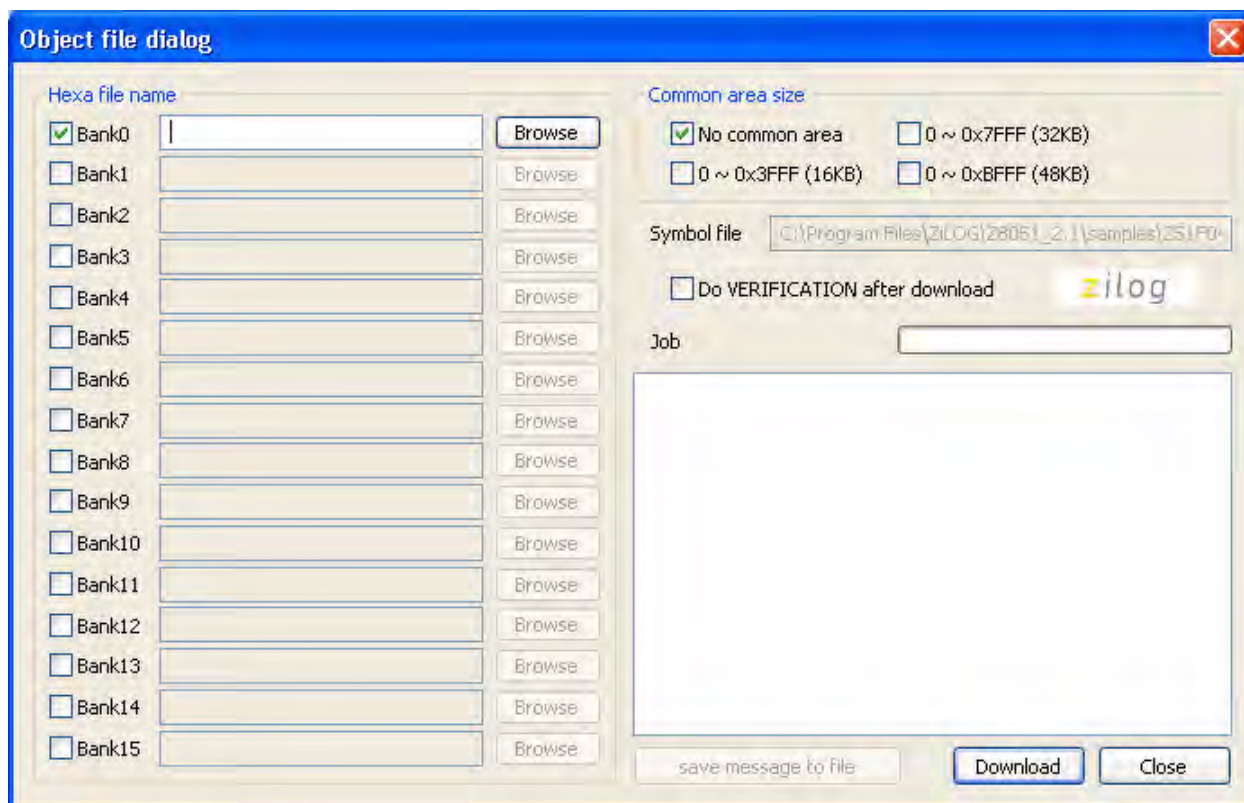

Figure 16. Object File Dialog

6. In the Object file dialog, browse to the hex file that you created in [Step 2](#) and click **Open**.
7. Click the **Download** button to open the Configuration dialog box, shown in Figure 17.

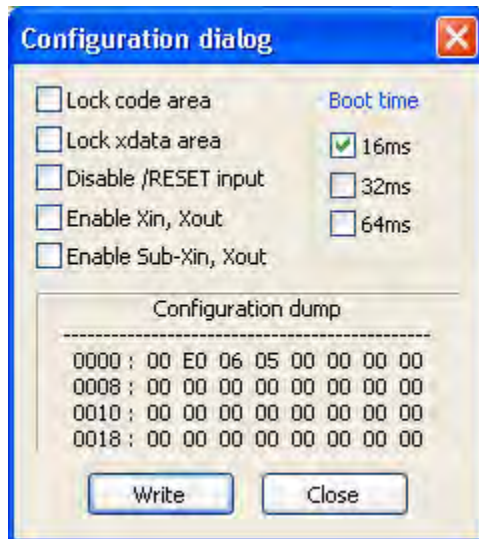

Figure 17. Configuration Dialog

8. Click the **Write** button to open the On-Chip Debugger's main window. A typical OCD display is shown in Figure 18; Figure 19 shows an OCD window with child windows open.

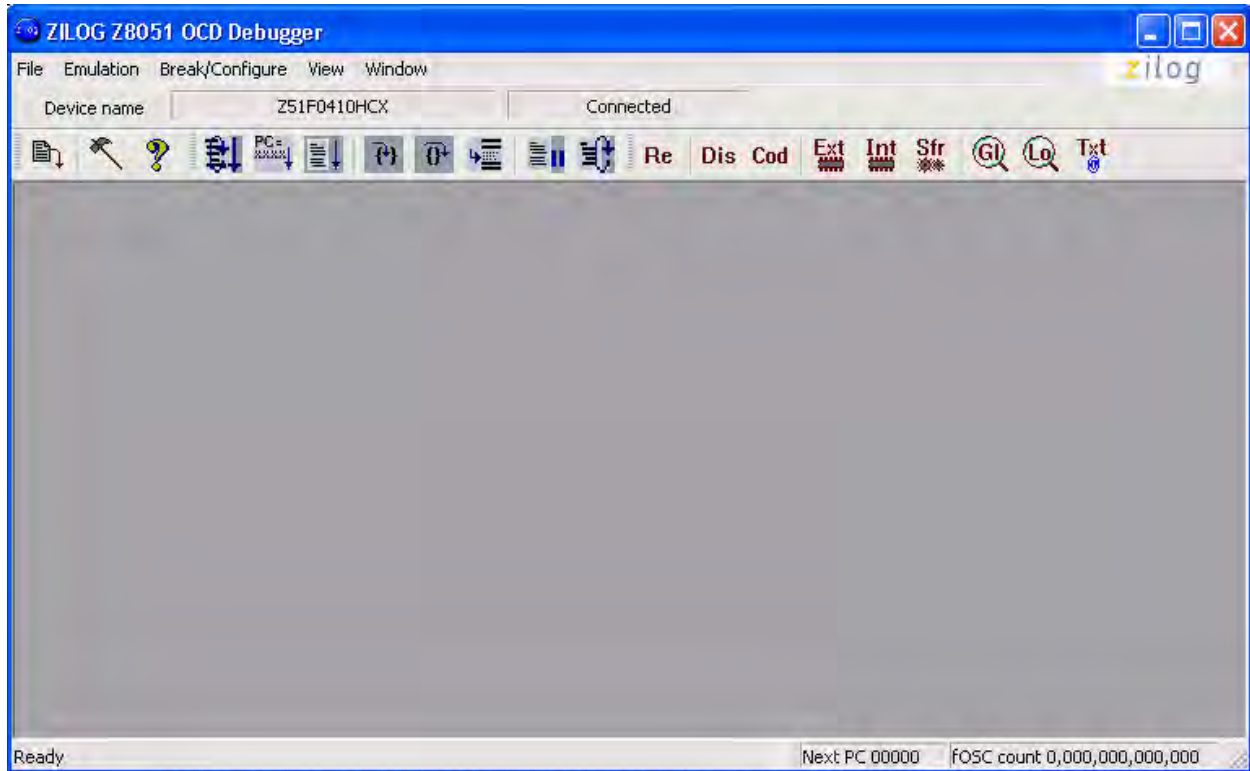

Figure 18. A Typical On-Chip Debugger Window

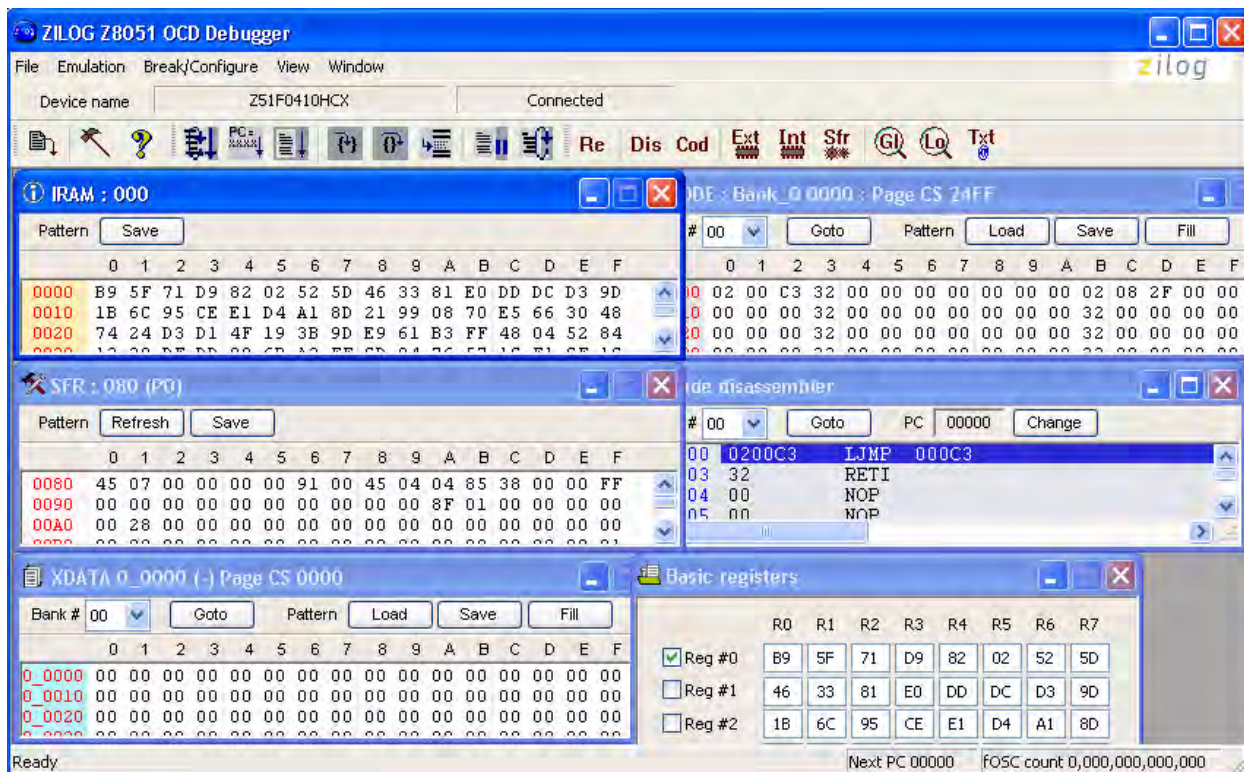

Figure 19. A Typical On-Chip Debugger with Child Windows Open

► **Note:** Use the View menu to open the child windows. For this demonstration, the example windows shown in Figure 19 do not need to be opened.

- Click the **Reset** toolbar icon of the OCD software, which is shown in Figure 20.



Figure 20. Reset Toolbar Icon

- Open HyperTerminal. Next, select the appropriate COM port and set it to 9600 8-N-1.
- From the **Emulation** menu of the OCD software, select **Go**. As a result, you should see the HyperTerminal message shown in Figure 21.

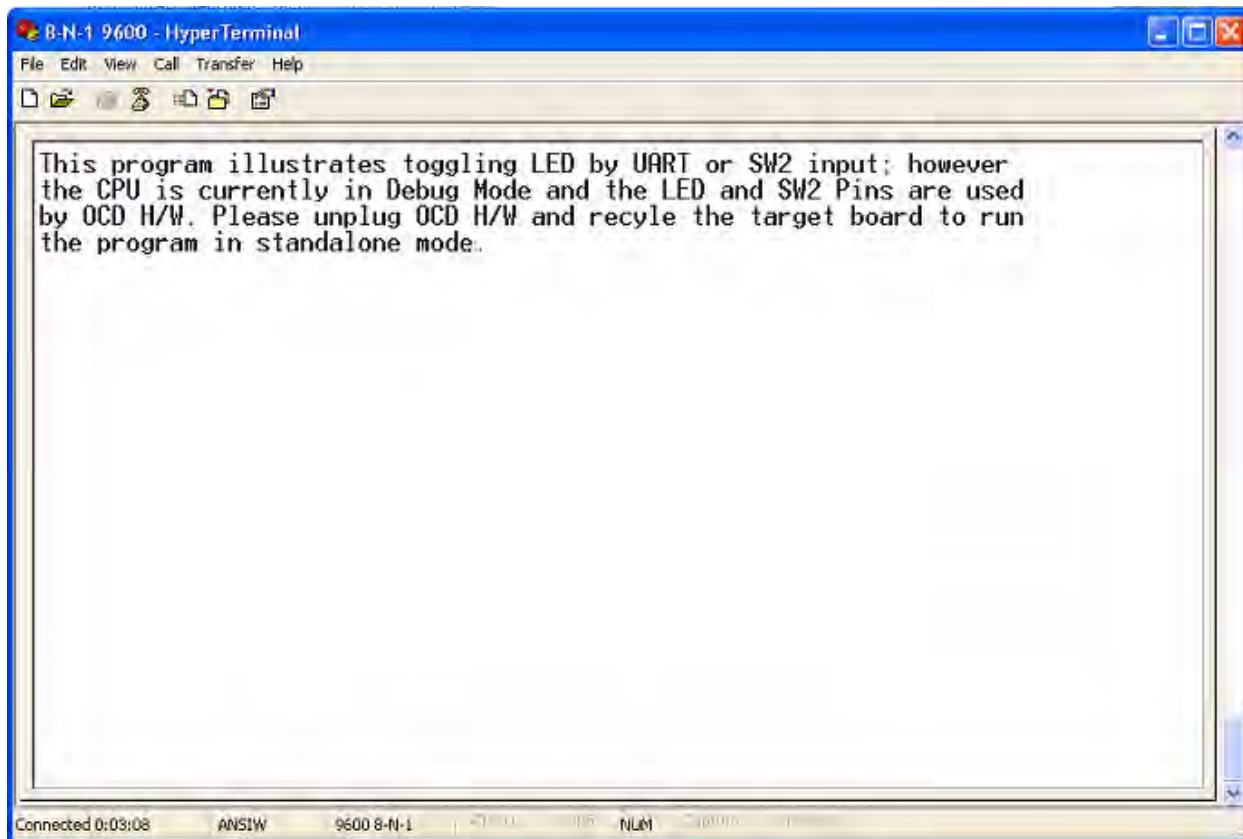

Figure 21. HyperTerminal Message After Selecting Go

12. Disconnect the OCD 10-ckt cable from the Evaluation Board.
13. Unplug the Evaluation Board from the PC.
14. Disconnect the HyperTerminal connection.
15. Plug the Evaluation Board into the PC's USB port.
16. Reestablish a HyperTerminal connection by clicking the **Call** button.
17. Press any key on the active HyperTerminal window; see Figure 22.

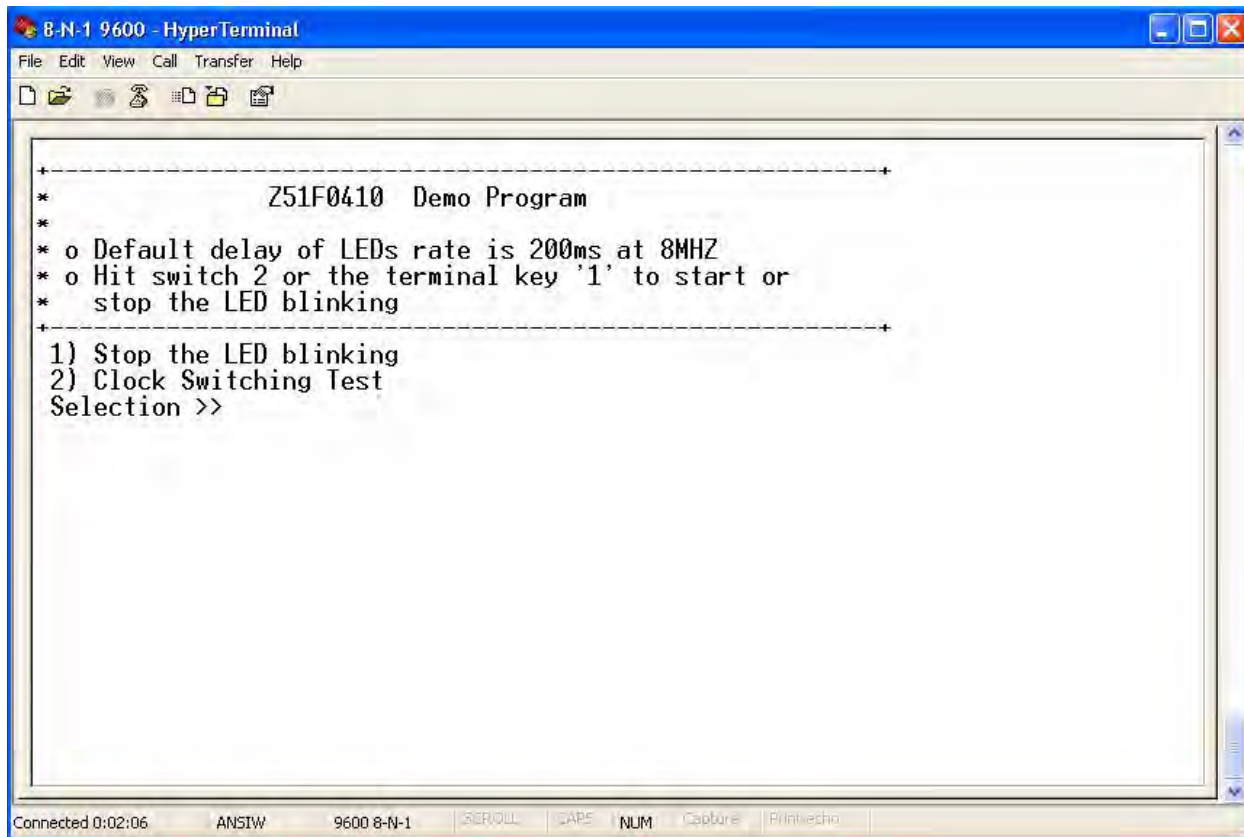

Figure 22. Z51F0410 Demo Program

18. Press SW2 on the Evaluation Board, or key in a 1 in the active HyperTerminal window to start/stop the blinking of LED D2.

► **Note:** Similar projects that you can use as references are listed in [Table 3](#) on page 36.

## Using the Keil $\mu$ Vision IDE on a Demo Project

Zilog's On-Chip Debugger hardware now fully supports the Keil  $\mu$ Vision IDE. Our target driver is seamlessly integrated with the Keil debugger, allowing Keil C51 users to work within the  $\mu$ Vision4 environment without switching between the Keil compiler and Zilog's external OCD software. In the demo project example that follows, the Z51F0410 MCU-related project is referenced as Demo.



- 
- **Notes:**
1. This document refers to the Keil  $\mu$ Vision IDE V4.53.0.6 (PK51 Prof. Developers Kit) or later.
  2. Refer to the [Z8051 Tools Product User Guide \(PUG0033\)](#) for additional information about these project files and debugging with the Keil  $\mu$ Vision IDE and Zilog On-Chip Debugger.
- 

### Debugger Configuration

Observe the following procedure to build and run a Z51F0410 demonstration project using the Keil  $\mu$ Vision IDE.

1. Start the Keil  $\mu$ Vision4 IDE.
2. From the **Project** menu, select **Open Project** and navigate to the following filepath:  
<Installation directory>\Z8051\_<version>\samples\Z51F0410\Demo
3. Select the Demo.uvproj file and click **Open**; see Figure 23.

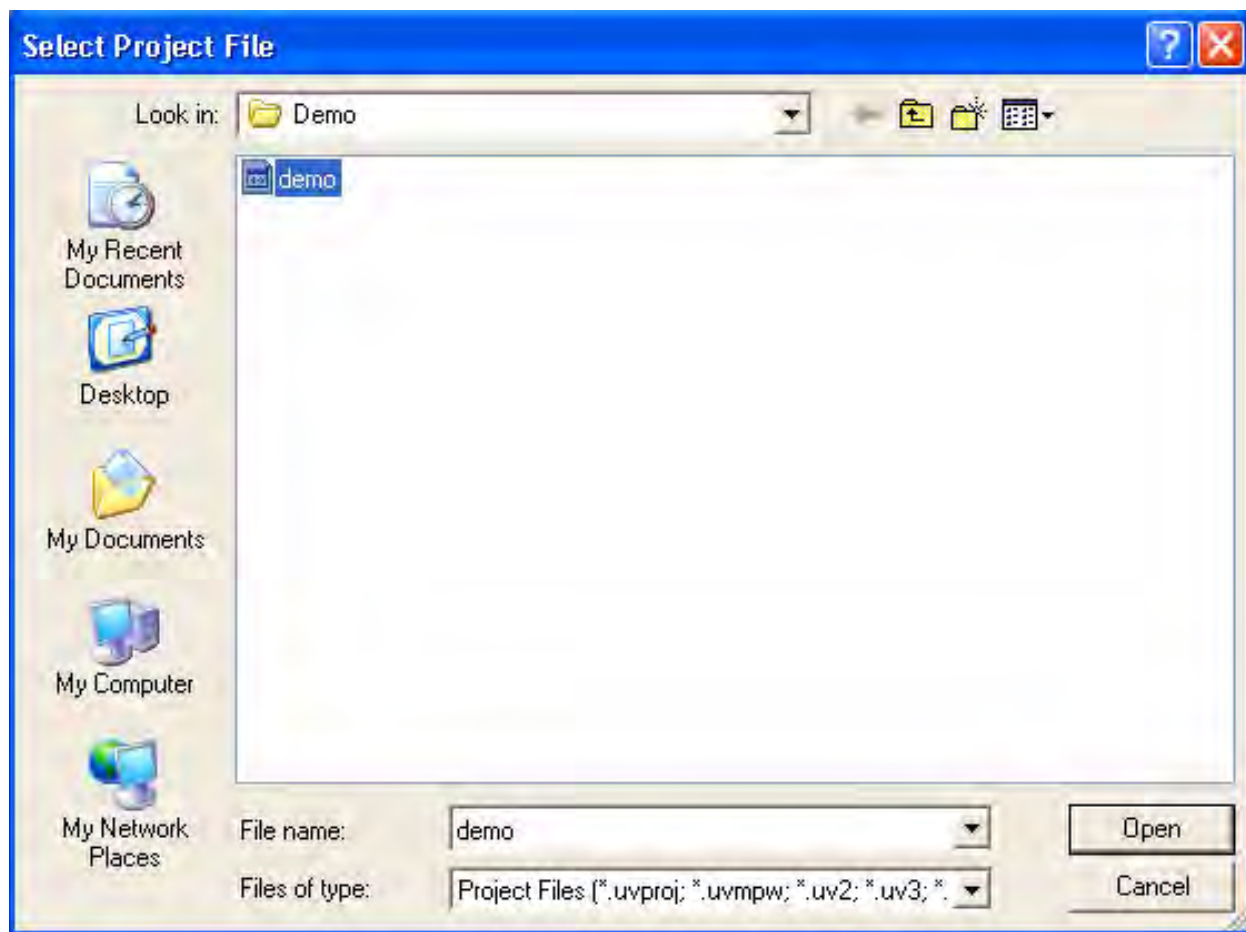

Figure 23. Selecting the Demo Project File

4. Return to the **Project** menu and select **Options for Target 'Demo'**.
5. In the Options for Target 'Demo' dialog that appears, click the **Device** tab and ensure that your target is properly selected for your project, as illustrated in Figure 24.

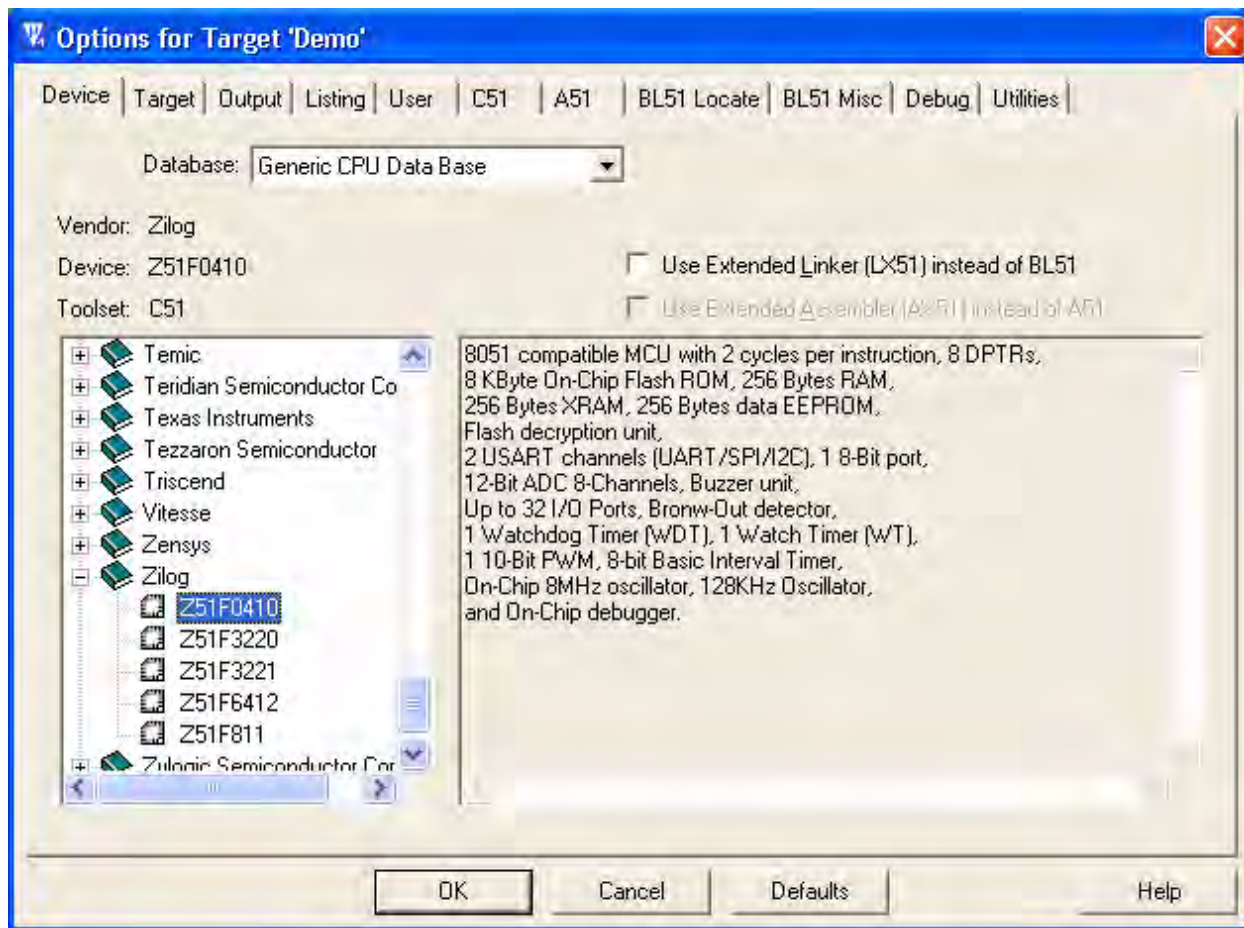

Figure 24. Selecting the Target

6. After selecting the target, click the **Debug** tab and select the **Zilog Z8051 Target Driver** from the **Use:** drop-down menu, as highlighted in Figure 25.

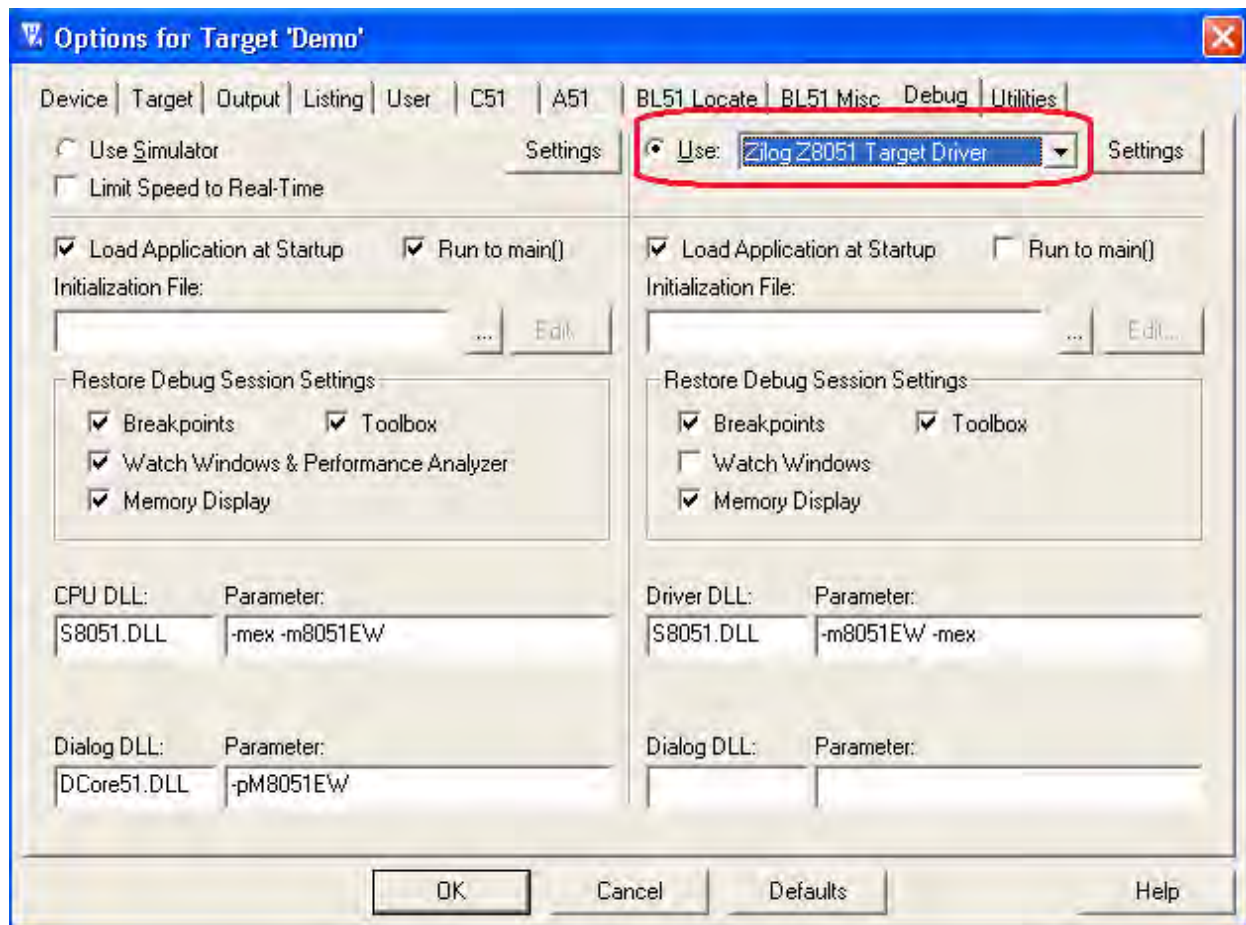

Figure 25. Selecting the Target Driver

7. Click the **Settings** button, located to the right of this drop-down menu, to configure your Debug and Flash options. The Settings dialog is displayed with the Debug Options tab appearing by default, as shown in Figure 26.

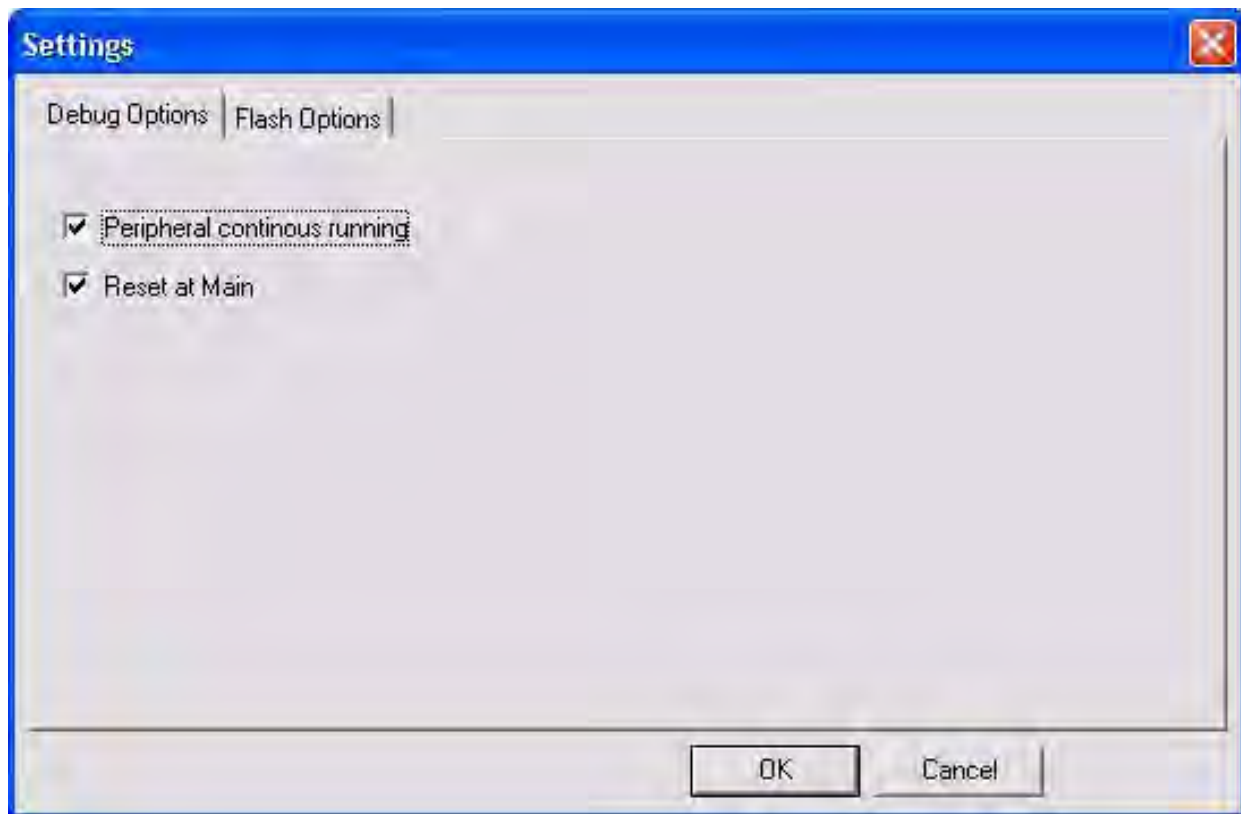

Figure 26. Configuring the Debug Options

- 
- **Notes:**
1. When configuring the appropriate Debug option, be aware of the following stipulations:
    - Checking the **Peripheral continues running** option means that the timers used in your project will run while the processor is stopped by the debugger.
    - The **Reset at Main** option will only work if you have a `main` file in your project; otherwise you should deselect this option.
  - 2.
- 
3. Click the **Flash Options** tab. The Flash Options Settings dialog will appear, as shown in Figure 27. To select the proper options for Flash programming, refer to the [Z51F0410 Product Specification \(PS0295\)](#).

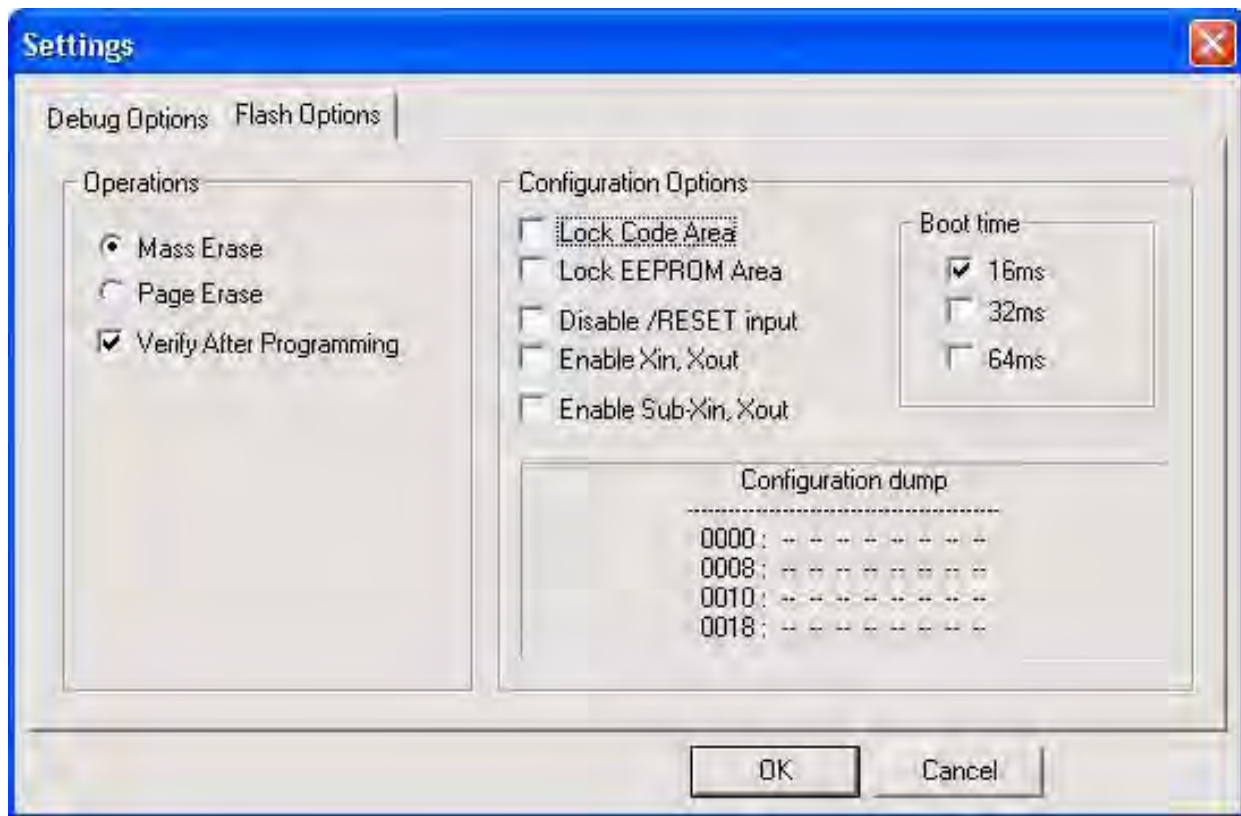

Figure 27. Configuring the Flash Options

4. Click **OK** to exit the Settings dialog.
5. From the **Options for Target 'Demo'** dialog, select the **Load Application at Startup** checkbox, as shown in Figure 28, the so that the IDE will download the code upon connection. There is no need to select or enter an initialization file.

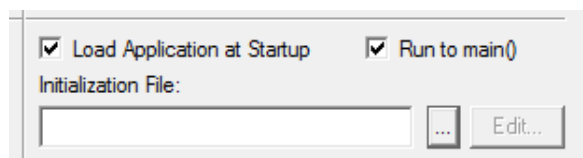

Figure 28. Load Application at Startup Settings

6. Click **OK** to exit the **Options for Target 'Demo'** dialog.
7. From the **Project** menu, select **Rebuild All** to rebuild all target files.

- Start your debugging session by clicking the **Start/Stop Debug Session** icon, as indicated in Figure 29. A default Windows configuration of the debug session is shown in Figure 30.

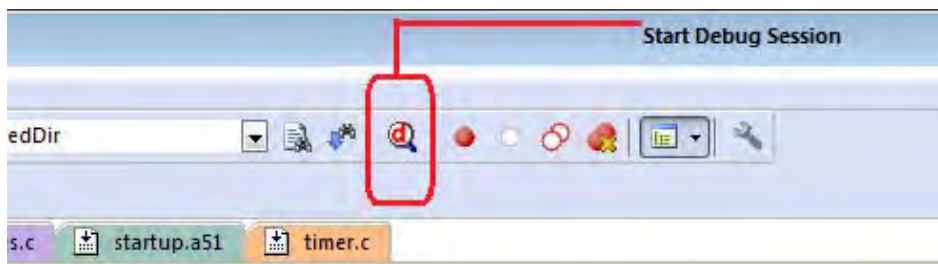

Figure 29. Beginning a Debug Session

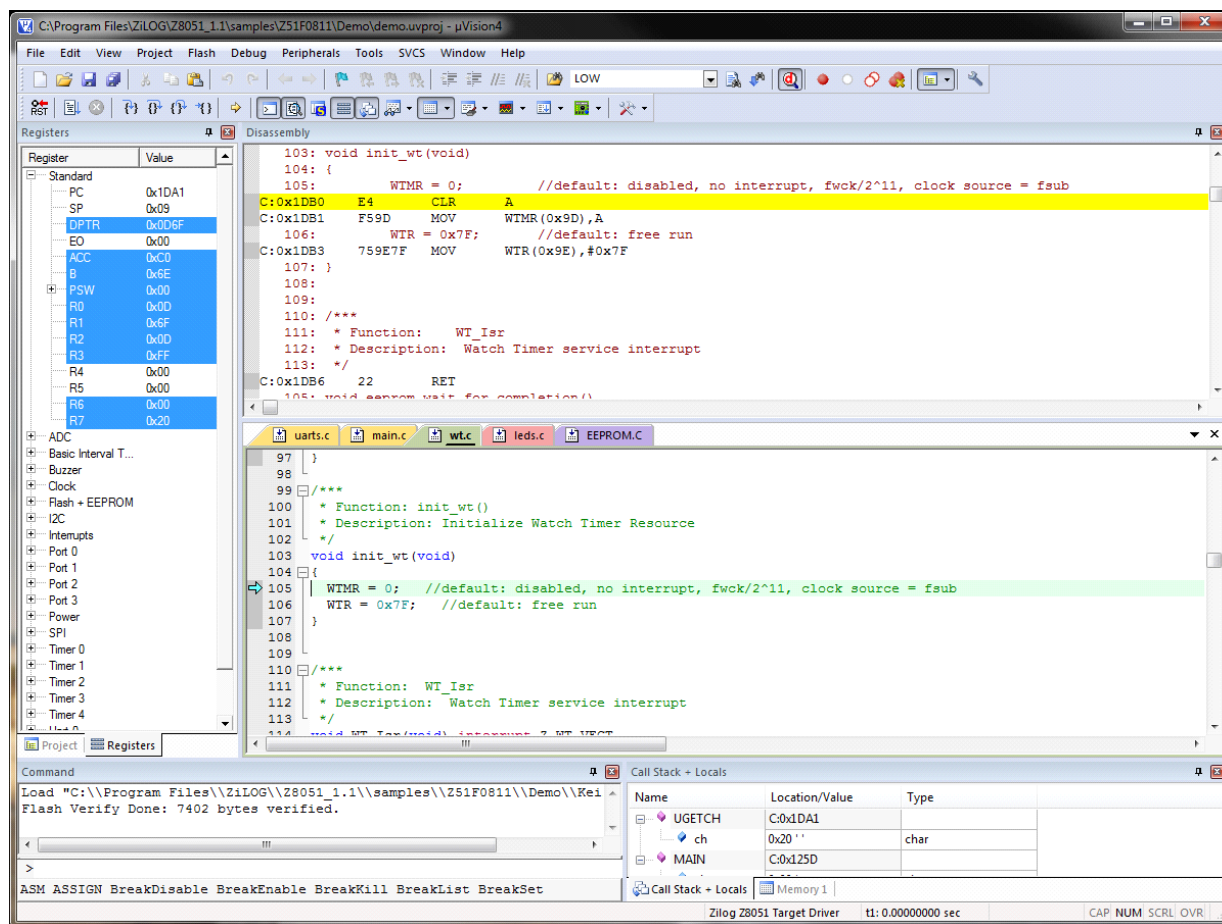

Figure 30. A Default Debug Session

- 
- **Note:** 1. The following buttons in the Keil  $\mu$  Vision IDE are not supported by the Zilog OCD driver:



2. To learn more about the full functionality of the Keil  $\mu$  Vision IDE, please refer to the Keil Keil  $\mu$  Vision4 IDE documentation.

- 
3. From the **Debug** menu, select **Reset CPU**.
  4. From the **Debug** menu, select **Run**. As a result, you should see the HyperTerminal message shown in [Figure 21](#) on page 24.
  5. Disconnect the OCD 10-ckt cable from the Evaluation Board.
  6. Unplug the Evaluation Board from the PC.
  7. Disconnect the HyperTerminal connection.
  8. Plug the Evaluation Board into the PC's USB port.
  9. Reestablish a HyperTerminal connection by clicking the **Call** button.
  10. Press any key on the active HyperTerminal window; see [Figure 22](#) on page 25.
  11. Press SW2 on the Evaluation Board, or key in a 1 in the active HyperTerminal window to start/stop the blinking of LED D2.
  12. To stop your debugging session, click the **Start/Stop Debug Session** icon.

- 
- **Note:** Refer to [Appendix D](#), on page 45 for a discussion of Stand-Alone Flash Programming Using the Keil  $\mu$  Vision IDE.
- 

## HyperTerminal Configuration

A communications program such as HyperTerminal can be used on Windows XP systems to view the messages from the Z51F0410 Evaluation Board. The following procedure examines how to configure HyperTerminal for the Z51F0410 demo project.

- 
- **Note:** The HyperTerminal application is not available in Windows Vista and Windows 7 systems. If you are using either of these operating systems, consider using/installing different com-



munication software, such as Tera Term. Please refer to the documentation for the particular emulation software you use to configure it for communication with the Z51F0410 Evaluation Board.

---

1. In HyperTerminal, select the COM port assigned to the USB-to-UART interface cable that is connected to the P1 connector on the Evaluation Board.
- 

► **Note:** This COM port can be determined from the Device Manager, as described in the the [FTDI USB-to-UART Driver Installation](#) section on page 13.

---

2. Configure this port to reflect the following settings:
  - 9600bps
  - 8 data bits
  - No parity
  - 1 stop bit
  - No flow control
3. Click the **Call** button to connect to the Z51F0410 Board. Upon connection, you should be able to see the Demo program menu shown in Figure 31.

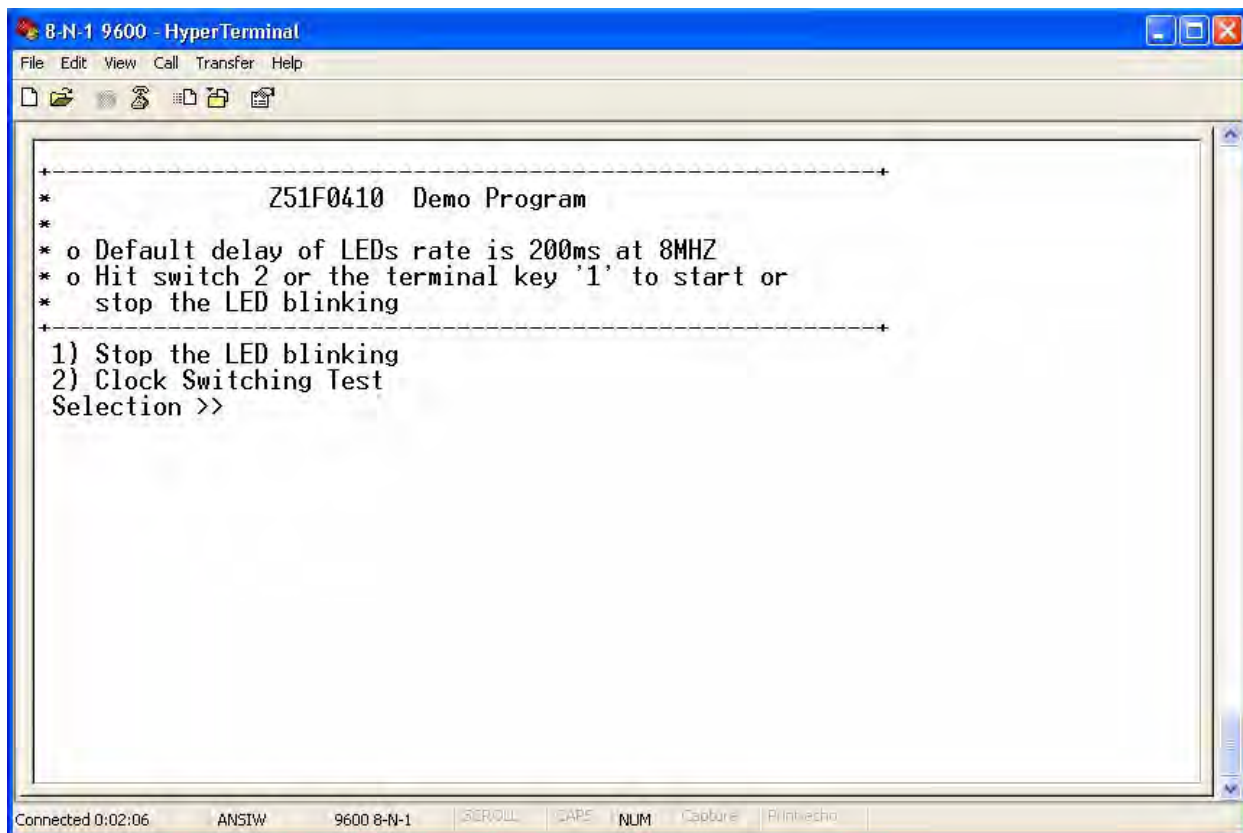

**Figure 31. Demo Program Menu in HyperTerminal**

At this point, you have successfully run the Z51F0410 demo project, but you are welcome to continue evaluating the demo in HyperTerminal. For additional information about how to create, edit, run and debug this project, please see the [Z8051 Tools Product User Guide \(PUG0033\)](#) and/or the [Z8051 On-Chip Debugger and In-System Programmer User Manual \(UM0240\)](#).

---

► **Note:** Turn off the power by removing the USB cable from the P1 connector on the Evaluation Board.

---

## Sample Projects and Documentation

A number of sample projects are included with the Z51F0410 Evaluation Kit installation software, and their locations, listed in Table 3, will be accessible upon installation.

**Table 3. Z51F0410 Evaluation Kit Sample Projects**

Description	Location
Demo	samples\Z51F0410\Demo
Led Blink	samples\Z51F0410\Led_Blink samples\Z51F0410\Led_Blink_Asm

A number of Z8051-related documents are included in the Z51F0410 Evaluation Kit, and their locations, listed in Table 4, will be accessible upon installation. You can also find current versions of each of these documents on the [Zilog website](#).

**Table 4. Z51F0410 Evaluation Kit Documentation**

Description	Document	Location
Z51F0410 Product Specification	PS0295	Documentation\Chip_Documentation
Z51F0811 Product Specification	PS0296	Documentation\Chip_Documentation
Z51F3220 Product Specification	PS0299	Documentation\Chip_Documentation
Z51F3221 Product Specification	PS0300	Documentation\Chip_Documentation
Z51F6412 Product Specification	PS0303	Documentation\Chip_Documentation
Z51F0410 Product Brief	PB0237	Documentation\Chip_Documentation
Z51F0811 Product Brief	PB0238	Documentation\Chip_Documentation
Z51F3220 Product Brief	PB0239	Documentation\Chip_Documentation
Z51F3221 Product Brief	PB0240	Documentation\Chip_Documentation
Z51F6412 Product Brief	PB0241	Documentation\Chip_Documentation
Z8051 OCD and ISP User Manual	UM0240	Documentation\Tools_Documentation
Z51F0410 Evaluation Kit User Manual	UM0257	Documentation\Tools_Documentation
Z51F0811 Evaluation Kit User Manual	UM0242	Documentation\Tools_Documentation
Z51F3220 Development Kit User Manual	UM0243	Documentation\Tools_Documentation
Z51F3221 Development Kit User Manual	UM0258	Documentation\Tools_Documentation
Z51F6412 Development Kit User Manual	UM0259	Documentation\Tools_Documentation
Z8051 Tools Product User Guide	PUG0033	Documentation\Tools_Documentation

# Appendix A. Schematic Diagrams

Figures 32 and 33 show schematic diagrams of the Z51F0410 Evaluation Board.

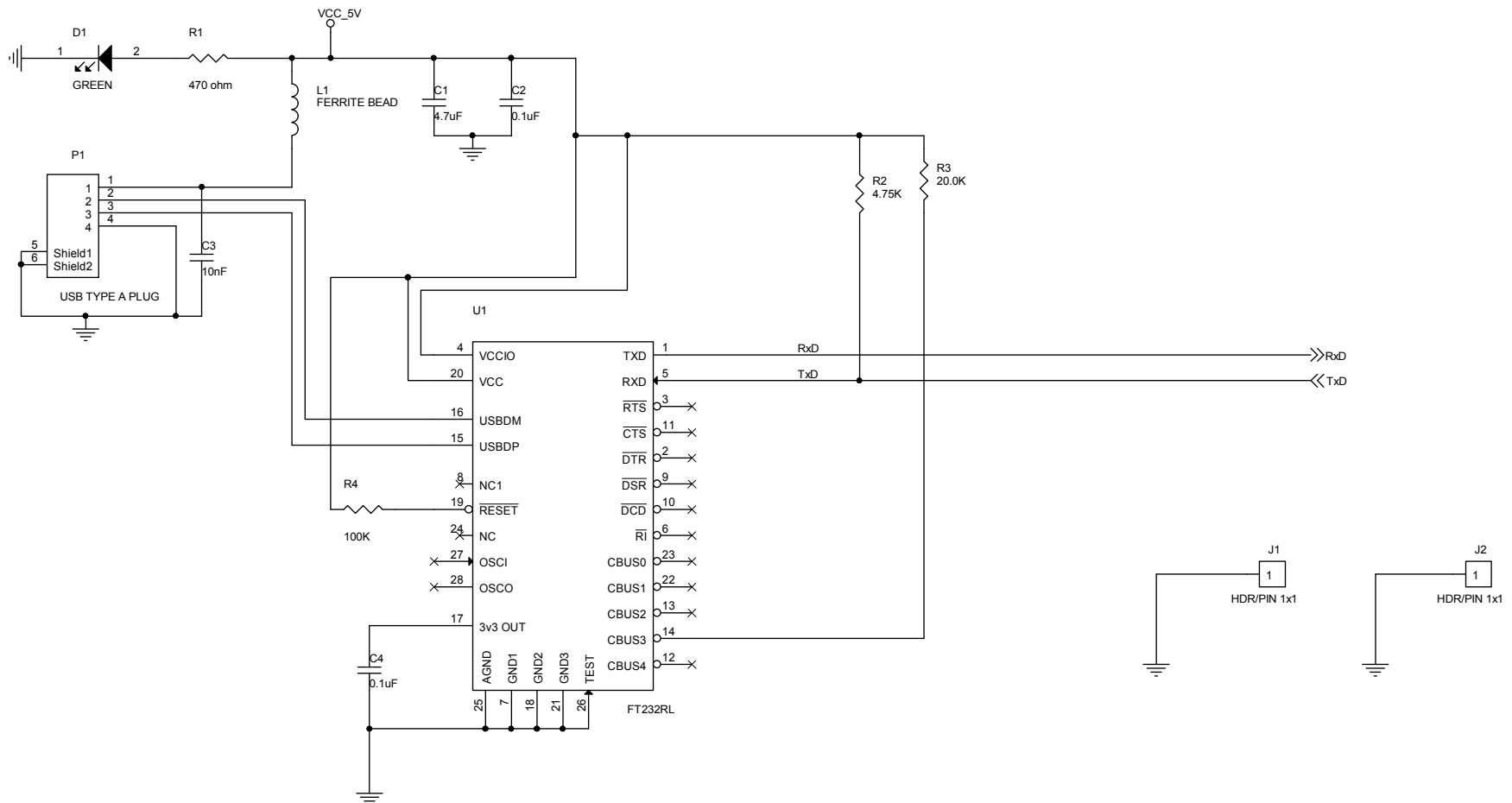

Figure 32. Z51F0410 Evaluation Board, #1 of 2

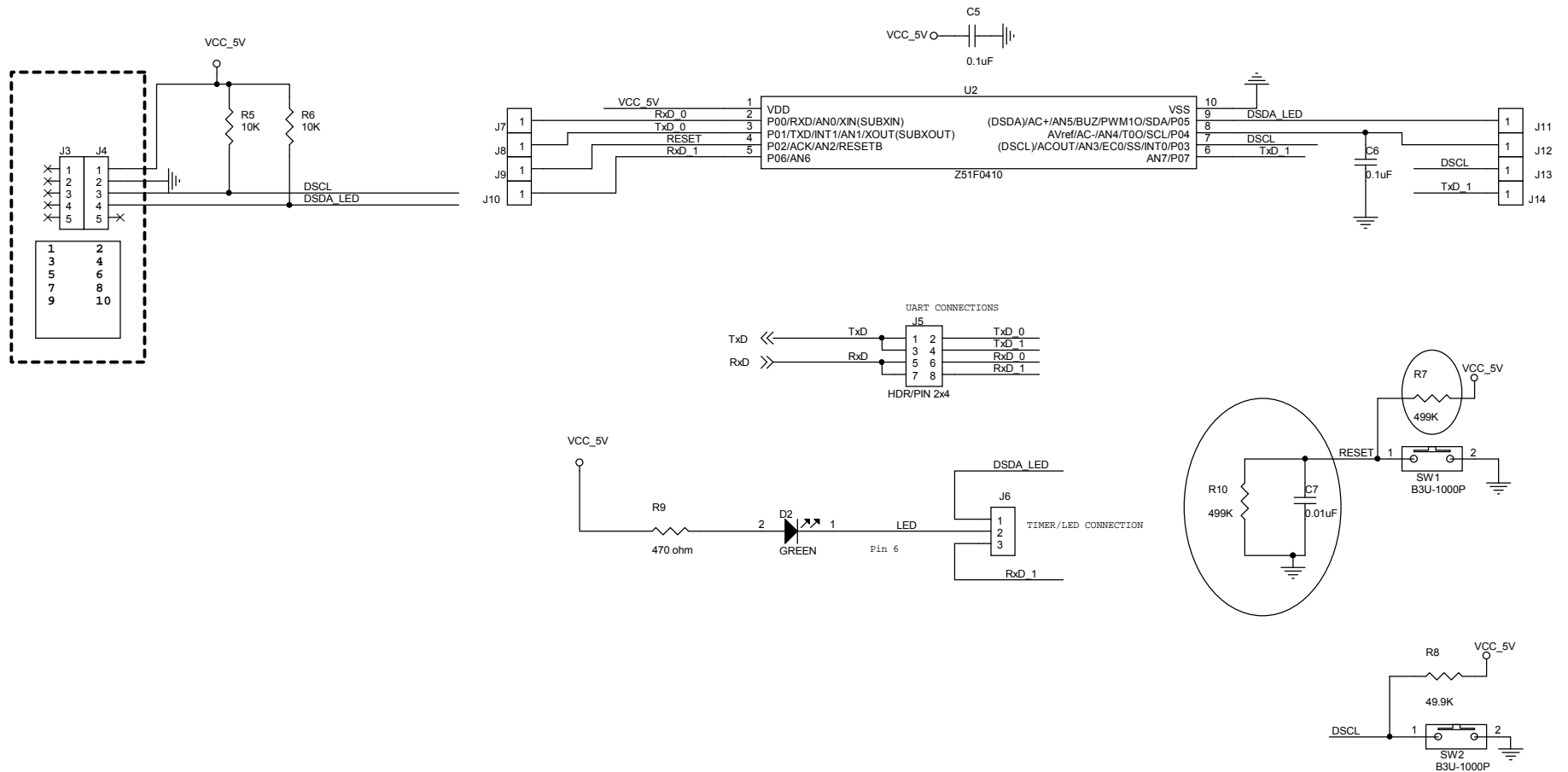

Figure 33. Z51F0410 Evaluation Board, #2 of 2

## Appendix B. OCD Driver Installation on Windows Vista Systems

The driver programs for the Z8051 On-Chip Debugger are copied to the development PC during the software and documentation installation. In the following procedure for PCs running Windows Vista 32- and 64-bit operating systems, ensure that the target side of the OCD will remain unconnected while you install these drivers.

1. Connect the OCD hardware to the USB port of your PC by connecting the A (male) end of the USB A (male)-to-Mini-B cables with the development PC's USB port. Connect the Mini-B end to the OCD device.
2. After the PC detects the new hardware, it will display the Found New Hardware Wizard dialog box, shown in Figure 34. Click **Locate and install driver software (recommended)**.

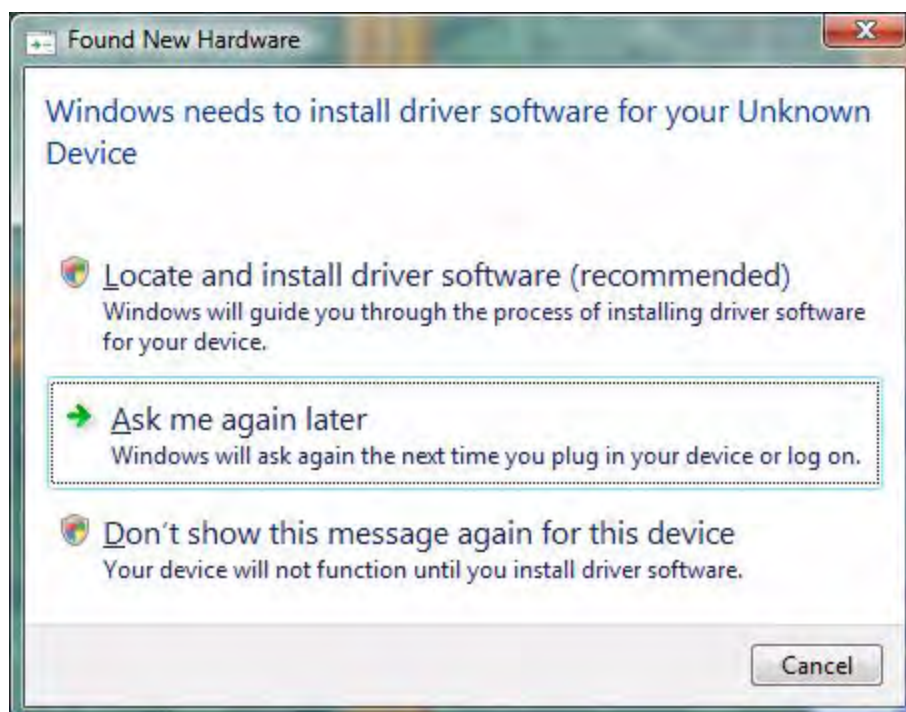

Figure 34. Found New Hardware Dialog, Windows Vista

3. Depending on your development PC's User Account Control settings, Windows may ask for permission to continue the installation. Click **Continue**.

4. When the **Insert the Disc** dialog appears, as shown in Figure 35, select **I don't have the disc. Show me other options.** Click the **Next** button to display the dialog that follows, which is shown in Figure 36.

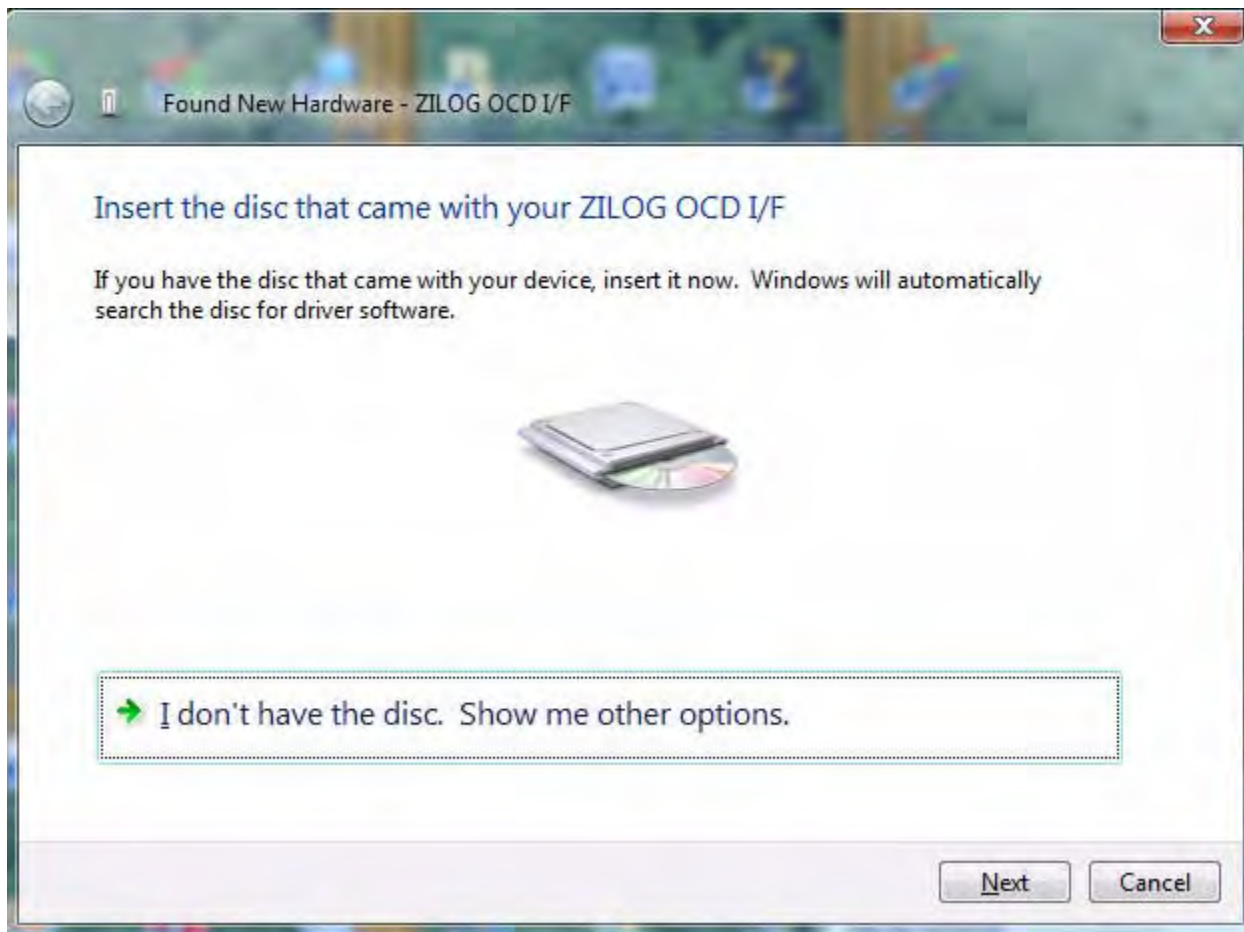

Figure 35. Install Device Driver Dialog, Windows Vista

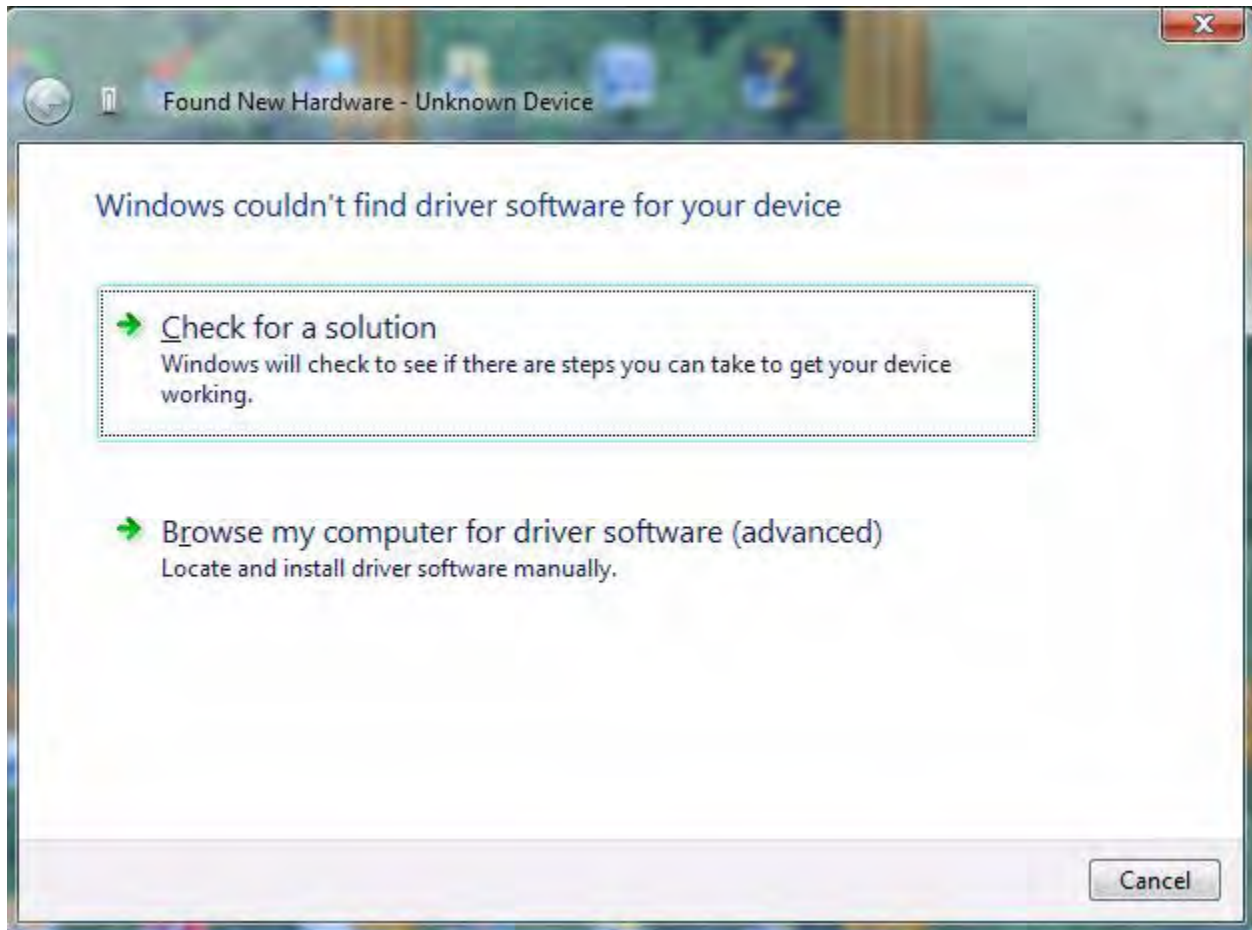

Figure 36. Couldn't Find Driver Dialog, Windows Vista

5. Return to page 6 and follow [Steps 3 through 6](#).



## Appendix C. OCD Driver Installation on Windows XP Systems

The driver programs for the Z8051 On-Chip Debugger are copied during the software and documentation installation. On Windows XP systems, ensure that the target side of the OCD will remain unconnected while you install these drivers. *It is important that you observe the following procedure; do not skip ahead until the OCD drivers are installed.*

1. Connect the OCD hardware to the USB port of your PC by connecting the A-Male end of the USB A (male)-to-Mini-B cables with the host PC's USB port, and connect the Mini-B end to the OCD device.
2. After the PC detects the new hardware, it will display the **Found New Hardware Wizard** dialog box, shown in Figure 37. Select **Install from a list or specific location (Advanced)**; then click **Next**.



Figure 37. The Found New Hardware Wizard Welcome Screen

3. The next dialog box, shown in Figure 38, prompts you to enter a path or navigate to the directory in which the .inf file was installed. Depending on the type of computer you use (32-bit or 64-bit), use the **Browse** button to navigate to one of the following paths and click the **Next** button, leaving all other selections at their default settings.
  - On 32-bit machines, use the following path:  
<Z8051 Installation>\Z8051\_<version\_number>\device drivers\OCD USB\x32
  - On 64-bit machines, use the following path:  
<Z8051 Installation>\Z8051\_<version\_number>\device drivers\OCD USB\x64

---

► **Note:** On some installations, the Found New Hardware screen shown in Figure 37 may also display the text string, Zilog Z8051 USB OCD - No Firmware. This occurrence is normal and can be disregarded.

---

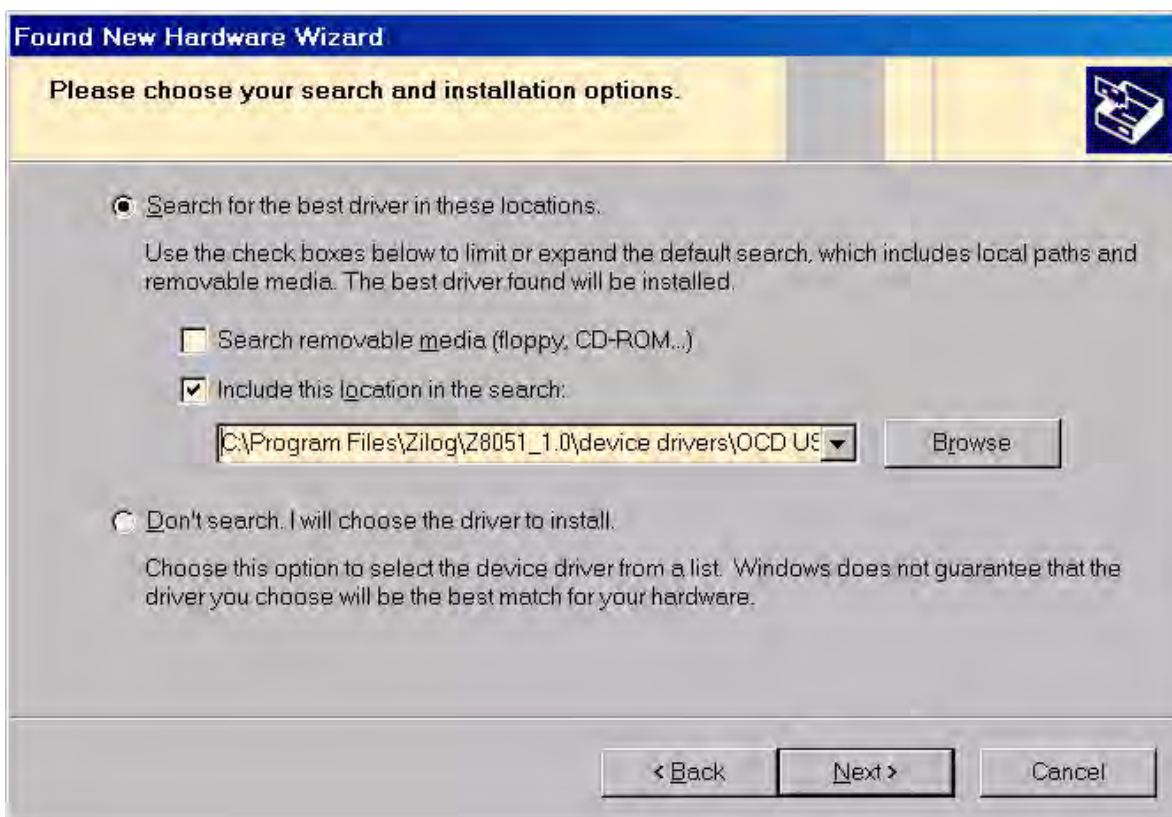

Figure 38. The Found New Hardware Wizard's Browse Screen

4. When Windows prompts you whether to continue the installation or stop, click the **Continue Anyway** button and wait until the installation is completed (Windows may prompt you more than once). When the installation is complete, click **Finish**.

## Appendix D. Stand-Alone Flash Programming Using the Keil $\mu$ Vision IDE

Observe the following procedure to program Flash memory without debugging.

1. From the **Project** menu, open the **Options for Target 'your project'**, and click the **Utilities** tab. In the **Use Target Driver for Flash Programming** drop-down menu within the Configure Flash Menu Command pane, ensure that **Zilog Z8051 Target Driver** is selected, as indicated in Figure 39.

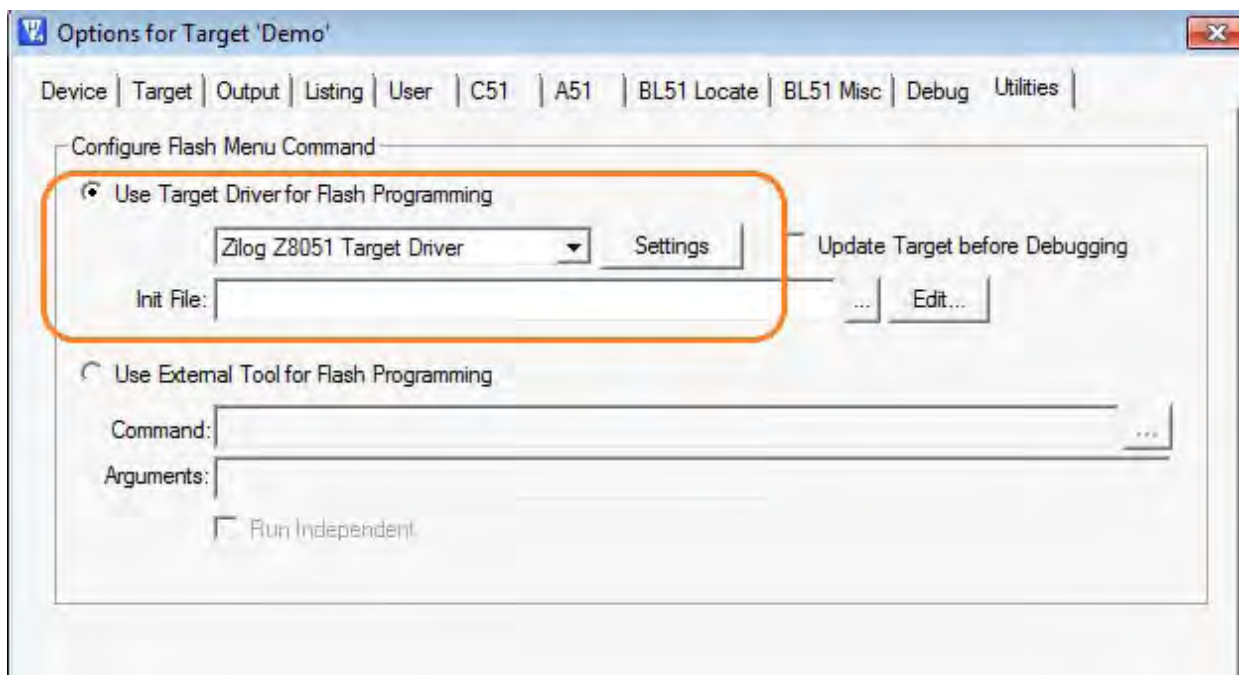

**Figure 39. Selecting A Target Driver For Flash Programming**

2. Click the **Settings** button to change any additional Flash options. The Settings dialog will appear, as shown in Figure 40.

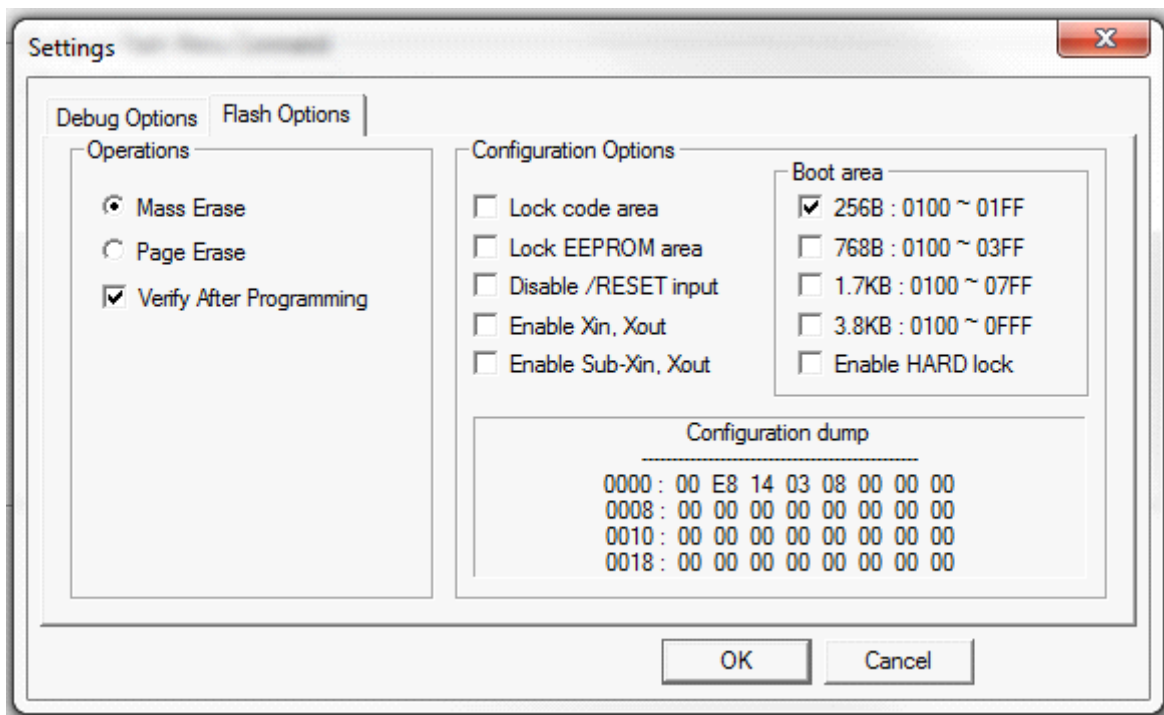

Figure 40. Configuring Additional Flash Options

3. After you have selected your Flash options, click **OK** to exit the **Flash Options** dialog.
4. Click **OK** to exit the **Options For Target 'Demo'** dialog.
5. From the **Flash** menu of the Keil IDE (see Figure 41), select either of the following options:
  - Select **Download** to program Flash memory with the current project
  - Select **Erase** to perform a mass erase of internal Flash memory

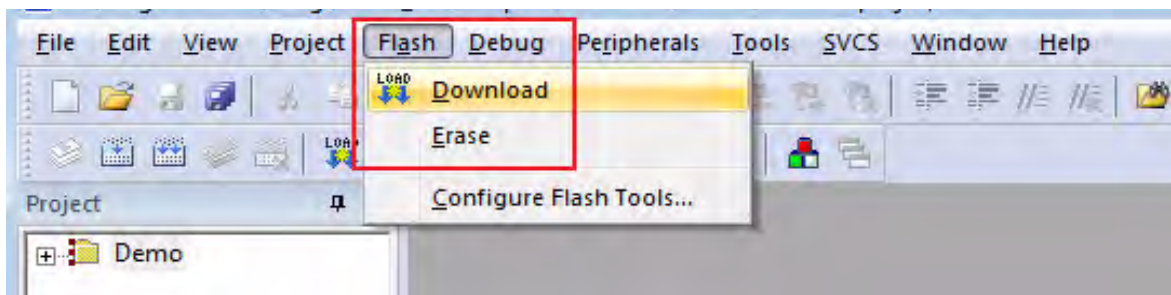

Figure 41. The Keil IDE Flash Menu

# Customer Support

To share comments, get your technical questions answered, or report issues you may be experiencing with our products, please visit Zilog's Technical Support page at <http://support.zilog.com>.

To learn more about this product, find additional documentation, or to discover other facets about Zilog product offerings, please visit the [Zilog Knowledge Base](#) or consider participating in the [Zilog Forum](#).

This publication is subject to replacement by a later edition. To determine whether a later edition exists, please visit the Zilog website at <http://www.zilog.com>.